

# Multiway ball valve Stainless Steel

## 4KH

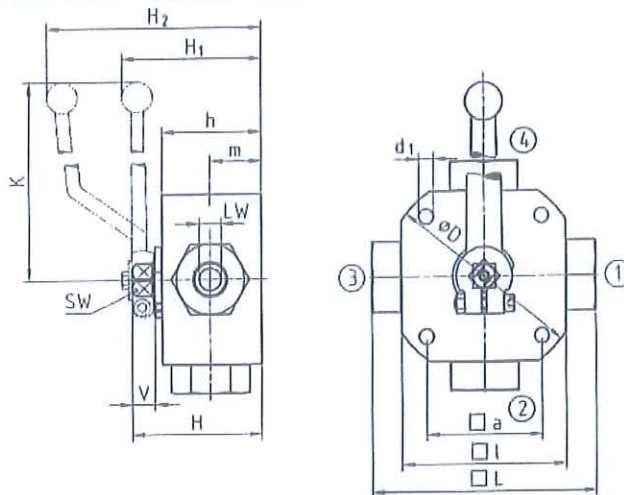

Multiway

### AVAILABLE SIZES

DN4 - DN25 (1/8" to 1")

### CONNECTIONS

DIN ISO 228 Female thread, ANSI B1.20.1 NPT Female thread, DIN 2353/ISO 8434-1 Light / Heavy series, SAE J 514/ISO/DIS11926-1 Female thread, others on request

### ACCESSORIES ON REQUEST

- Locking devices page 226 - 229
- Actuators 224 - 225
- Mounting holes on request
- Position switches on request
- Combinations 196 - 199
- Detent 235

### MATERIAL CODE DESCRIPTION

Materials	442A	442A	442B	442B
Body	Stainless Steel	Stainless Steel	Stainless Steel	Stainless Steel
Trunnion ball	Stainless Steel	Stainless Steel	Stainless Steel	Stainless Steel
Ball seats	POM	POM	POM	POM
O-rings	NBR	NBR	FPM	FPM
Tmin / Tmax	-30°C / 100°C	-30°C / 100°C	-20°C / 100°C	-20°C / 100°C
Porting pattern	T=SB13	X=SB14	T=SB13	X=SB14

### GENERAL DIMENSIONS

Type	LW <sub>Cr</sub>	LW <sub>A</sub>	D	a	l	d <sub>1</sub>	H	h	m	K	V	SW	H <sub>1</sub>	H <sub>2</sub>	Lever
4KH-DN4	5	4	75	40	70	6,5	58	40	22	160	14	12	-	101	Al
4KH-DN6	5	4	75	40	70	6,5	58	40	22	160	14	12	-	101	Al
4KH-DN8	8	7	90	45	80	6,5	68	50	27	200	14	14	72	-	Zn
4KH-DN10	8	7	90	45	80	6,5	68	50	27	200	14	14	72	-	Zn
4KH-DN13	13	10	110	60	100	9	78	60	31	200	14	14	82	-	Zn
4KH-DN16	13	10	110	60	100	9	78	60	31	200	14	14	82	-	Zn
4KH-DN20	18	14	138	85	113	8,5	88	67	36,5	320	16,5	17	96	-	Al
4KH-DN25	23	17	138	85	119	8,5	103	82	47,5	320	16,5	17	112	-	Al
4KH-DN25/32	23	17	138	85	119	8,5	103	82	47,5	320	16,5	17	112	-	Al
4KH-DN25/40	23	17	138	85	119	8,5	103	82	47,5	320	16,5	17	112	-	Al

# Multiway ball valve Stainless Steel

## 4KH

CONNECTION TYPE	DIMENSIONS					ORDER CODE PER MATERIAL COMBINATION				
	Type	L	i	d	Weight (kg)	PN (bar)	442A T=5813	442A X=5814	4428 T=5813	4428 X=5814
DIN ISO 228 FEMALE THREAD	4KH-DN4-G1/8	100	10	G1/8	1,80	500	37443	37444	39144	39145
	4KH-DN6-G1/4	100	14	G1/4	1,60	500	37446	20172	39146	31150
	4KH-DN10-G3/8	115	14	G3/8	2,80	500	37509	09823	39147	35755
	4KH-DN13-G1/2	136	16,3	G1/2	4,90	400	36026	21366	39148	26811
	4KH-DN16-G5/8	139	18	G5/8	4,90	400	37512	37513	39149	39151
	4KH-DN20-G3/4	154	18	G3/4	6,80	315	37515	35477	39150	28850
	4KH-DN25-G1	172	20	G1	8,50	315	10212	37521	39152	39153
	4KH-DN25/32-G1 1/4	180	22	G1 1/4	8,80	315	37519	37522	39154	39155
	4KH-DN25/40-G1 1/2	180	24	G1 1/2	8,80	250	37520	37523	39156	39157

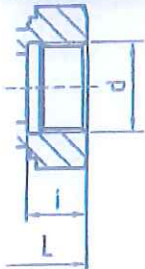

CONNECTION TYPE	DIMENSIONS					ORDER CODE PER MATERIAL COMBINATION				
	Type	L	i	d	Weight (kg)	PN (bar)	442A T=5813	442A X=5814	4428 T=5813	4428 X=5814
ANSI B1.20.1 NPT FEMALE THREAD	4KH-DN4-1/8"NPT	100	10,5	1/8"NPT	1,60	500	38115	38116	39158	39159
	4KH-DN6-1/4"NPT	100	13,7	1/4"NPT	1,60	500	38117	32668	39160	32428
	4KH-DN10-3/8"NPT	115	13,5	3/8"NPT	2,80	500	38118	38119	39161	32499
	4KH-DN13-1/2"NPT	160	17	1/2"NPT	4,90	400	38120	32185	39162	39163
	4KH-DN20-3/4"NPT	164	18,3	3/4"NPT	6,80	315	38121	38122	39164	34083
	4KH-DN25-1"NPT	186	21,6	1"NPT	8,50	315	38123	38126	39165	39166
	4KH-DN25/32-1 1/4"NPT	186	22,1	1 1/4"NPT	8,80	315	38124	32310	39167	39168
	4KH-DN25/40-1 1/2"NPT	186	22,1	1 1/2"NPT	8,80	250	38125	38127	39169	39170

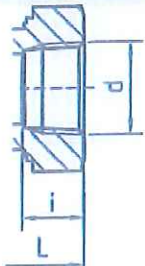

CONNECTION TYPE	DIMENSIONS					ORDER CODE PER MATERIAL COMBINATION					
	Type	RA	L	i	d	Weight (kg)	PN (bar)	442A T=5813	442A X=5814	4428 T=5813	4428 X=5814
DIN 2353 / ISO 8434-1 LIGHT SERIES	4KH-DN4-6L	6	105	7	M 12x1,5	1,60	500	37379	37380	39113	39114
	4KH-DN6-8L	8	105	7	M 14x1,5	1,80	500	37382	37383	39115	39116
	4KH-DN8-10L	10	114	7	M 16x1,5	2,60	500	37385	37386	39117	39118
	4KH-DN10-12L	12	114	7	M 18x1,5	2,60	500	37388	37389	39119	39120
	4KH-DN13-15L	15	137	7	M 22x1,5	4,70	400	37391	37392	39121	39122
	4KH-DN16-18L	18	137	7,5	M 26x1,5	4,70	400	37394	37395	39123	39124
	4KH-DN20-22L	22	152	7,5	M 30x2	6,60	315	37397	37398	39125	39126
	4KH-DN25-28L	28	166	7,5	M 36x2	8,00	315	37400	37401	39127	39128
	4KH-DN25/32-35L	35	170	10,5	M 45x2	8,12	315	41950	41951	41952	41953

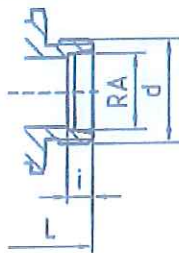

CONNECTION TYPE	DIMENSIONS					ORDER CODE PER MATERIAL COMBINATION					
	Type	RA	L	i	d	Weight (kg)	PN (bar)	442A T=5813	442A X=5814	4428 T=5813	4428 X=5814
DIN 2353 / ISO 8434-1 HEAVY SERIES	4KH-DN4-8S	8	105	7	M 16x1,5	1,80	500	37414	37415	39129	39130
	4KH-DN6-10S	10	105	7,5	M 18x1,5	1,60	500	37417	37418	39131	39132
	4KH-DN8-12S	12	116	7,5	M 20x1,5	2,60	500	37420	19830	39133	39134
	4KH-DN10-14S	14	120	8	M 22x1,5	2,60	500	37422	37423	39135	39136
	4KH-DN13-16S	16	141	8,5	M 24x1,5	4,70	400	37425	37426	39137	26186
	4KH-DN16-20S	20	145	10,5	M 30x2	4,70	400	37428	22234	39138	39139
	4KH-DN20-25S	25	160	12	M 36x2	6,60	315	37430	37431	39140	39141
	4KH-DN25-30S	30	176	13,5	M 42x2	8,20	315	37433	37432	39142	39143
	4KH-DN25/32-38S	38	180	16	M 52x2	8,30	315	41954	41955	41956	41957

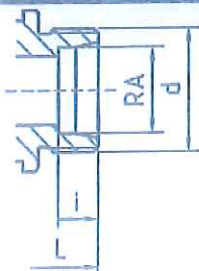

Please note the pressure ratings of the tube connections!

\*Article usually in stock.

# Multiway ball valve Stainless Steel

## 4KH

### CONNECTION TYPE

SAE J514/ISO/DI511926-1  
FEMALE THREAD

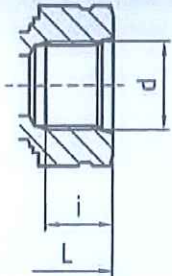

### DIMENSIONS

Type	L	i	d	Weight (kg)
4KH-DN6-7/16"UNF	100	12	7/16"-20 UNF	1,60
4KH-DN10-9/16"UNF	115	13	9/16"-18 UNF	2,80
4KH-DN13-3/4"UNF	144	15	3/4"-16 UNF	4,90
4KH-DN20-1 1/16"UN	164	20	1 1/16"-12 UN	6,80
4KH-DN25-1 5/16"UN	180	20	1 5/16"-12 UN	8,50

### ORDER CODE PER MATERIAL COMBINATION

PN (bar)	442A T=SB13	442A X=SB14	4428 T=SB13	4428 X=SB14
500	38199	38200	39178	39179
500	38201	38202	39180	39181
400	38203	38204	39182	39183
315	38205	38206	39184	39185
315	38207	38208	39186	39187

Multiway

Please note the pressure ratings of the tube connections!

\*Article usually in stock.

### PORTING PATTERNS

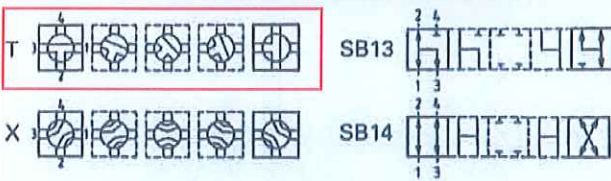

Further porting patterns page 262 to 267

### FLOW CHARACTERISTICS 4KH-X/T

