

Cable-Extension Position Transducer

0/4...20 mA Output

Ranges: 0-10 to 0-250 inches

Industrial Grade



PT5MA

Specification Summary:

GENERAL
 Full Stroke Range Options 0-10 to 0-250 inches
 Output Signal Options 4...20 mA (2-wire) and 0...20 mA (3-wire)
 Accuracy $\pm 0.75\%$ to $\pm 0.18\%$ full stroke *see ordering information*
 Repeatability *see ordering information*
 Resolution essentially infinite
 Measuring Cable Options stainless steel or thermoplastic
 Enclosure Material hard anodized aluminum
 Sensor plastic-hybrid precision potentiometer
 Potentiometer Cycle Life *see ordering information*
 Maximum Measuring Cable Velocity *see ordering information*
 Maximum Retraction Acceleration *see ordering information*
 Weight 5 lbs. max.

ELECTRICAL
 Input Voltage *see ordering information*
 Input Current 20 mA max.
 Maximum Loop Resistance (Load) (loop supply voltage – 8)/0.020
 Circuit Protection 38 mA max.
 Impedance 100 M ohms @ 100 VDC, min.
 Output Signal Adjustment
 Zero Adjustment from factory set zero to 50% of full stroke range
 Span Adjustment to 50% of factory set span

ENVIRONMENTAL
 Enclosure NEMA 4/6, IP 65/67
 Operating Temperature -40° to 200°F (-40° to 90°C)
 Vibration up to 10 G's to 2000 Hz maximum

EMC COMPLIANCE PER DIRECTIVE 89/336/EEC
 Emission / Immunity EN50081-2 / EN50082-2

Outline Drawing

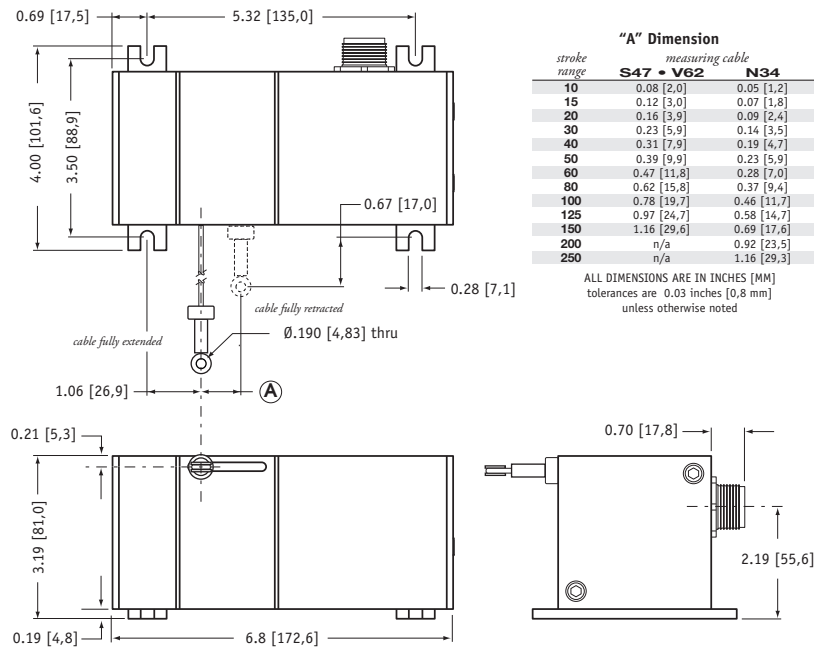

The PT5MA potentiometric cable-extension transducer uses a unique thermoplastic cable that has virtually an infinite fatigue life. This cable, known as V62, has properties that are superior for high cycle and rugged applications.

Like Celesco's other transducers, the PT5MA installs in minutes, functions properly without perfectly parallel alignment, and fits easily into small areas. The PT5MA offers additional installation flexibility since its cable exit can be rotated relative to the mounting surface, providing four different cable exit orientations.

Output Signal

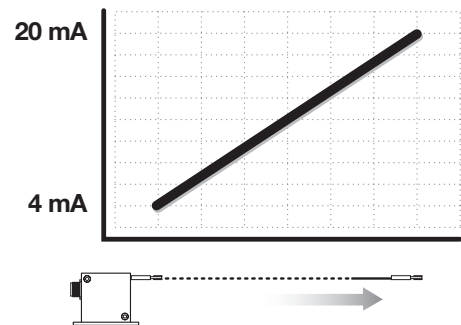

Ordering Information:

Model Number:

PT5MA - _____ - _____ - _____ - _____ - _____
order code: **R** **A** **B** **C** **D**

Sample Model Number:

PT5MA - 100 - N34 - FR - 420E - M6

- R** range: 100 inches
- A** measuring cable: .034 nylon-coated stainless front
- B** cable exit: front
- C** output signal: 4...20 mA
- D** electrical connection: 6-pin plastic connector

Full Stroke Range:

R order code:	10	15	20	25	30	40	50	60	80	100	125	150	200	250
full stroke range, min:	10 in.	15 in.	20 in.	25 in.	30 in.	40 in.	50 in.	60 in.	80 in.	100 in.	125 in.	150 in.	200 in.	250 in.
accuracy (±% of f.s.):	.75%	.6%	.5%	.5%	.5%	.3%	.3%	.25%	.25%	.25%	.25%	.18%	.18%	.18%
repeatability (±% of f.s.):	.1%	.1%	.05%	.05%	.05%	.05%	.05%	.02%	.02%	.02%	.02%	.02%	.02%	.02%
potentiometer cycle life:	2,500,000 cycles						500,000 cycles						250,000 cycles	
cable tension (20%):	41 ounces												21 ounces	
max. cable velocity/acceleration:	300 in./sec • 5 G's												120 in./sec • 2 G's	

Measuring Cable:

A order code:

N34	S47	V62
.034 nylon-coated stainless steel <i>available in all ranges</i>	.047 stainless steel <i>all ranges up to 150 inches</i>	.062 thermoplastic <i>all ranges up to 150 inches</i>

Cable Exit:

B order code:

UP up	DN down	FR front	BK back
inches [mm]			

Output Signals:

C order code:

	420E	420R	020E	020R
output signal options:	4...20 mA 	20...4 mA 	0...20 mA 	20...0 mA
sensitivity:	16 mA/full stroke ±0.25%		20 mA/full stroke ±0.25%	
wiring configuration:	2 - wire		3 - wire	
input voltage:	8 - 34 vdc		14 - 29 vdc	



example:

ordercode = **420E** = 4...20 mA →
 4 mA =
 20 mA =

Ordering Information (cont.)

Electrical Connection:

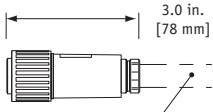
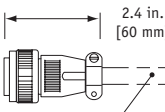
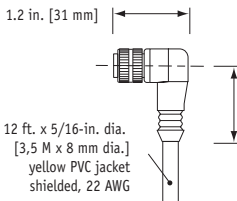
① *order code:*

M6	M6M	MC4	C25
6-pin plastic connector with mating plug IP 67, NEMA 6	6-pin metal connector with mating plug IP 65, NEMA 4	4-pin micro-connector with 12 ft [3.5 M] cordset IP 67, NEMA 6	25-ft. instrumentation cable 24 AWG, shielded IP 67, NEMA 6
			
.30 - .39 in. [8 - 10 mm] cable dia. 16 AWG max conductor size connector: MS3102E-14S-6P mating plug: MS3106E-14S-6S	.375 in. [9 mm] max cable dia. 16 AWG max conductor size connector: MS3102E-14S-6P mating plug: MS3106E-14S-6S	12 ft. x 5/16-in. dia. [3.5 M x 8 mm dia.] yellow PVC jacket shielded, 22 AWG	25 ft. x 0.2-in. dia. [7.5 M x 5 mm dia.] 24 AWG, shielded

6-pin mating plug:

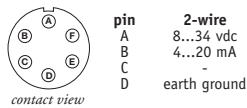

pin	2-wire	3-wire
A	8...34 vdc	14...29 vdc
B	4...20 mA	common
C	-	0...20 mA
D	earth ground	-

4-pin mating plug and cordset:



pin	color code	2-wire	3-wire
1	RED-BLK TR.	8...34 vdc	14...29 vdc
2	RED-WHT TR.	4...20 mA	0...20 mA
3	RED	-	common
4	GREEN	earth ground	-

25-ft. cable:

color code	2-wire	3-wire
RED	8...34 vdc	14...29 vdc
BLACK	4...20 mA	common
WHITE	-	-
GREEN	earth ground	0...20 mA

Output Signal Selection:

The output signal direction can be reversed at any time by simply changing the dip-switch settings found on the internal signal board. After the settings have been changed, adjustment of the Zero and Span trimpots will be required to precisely match signal values to the beginning and end points of the stroke.

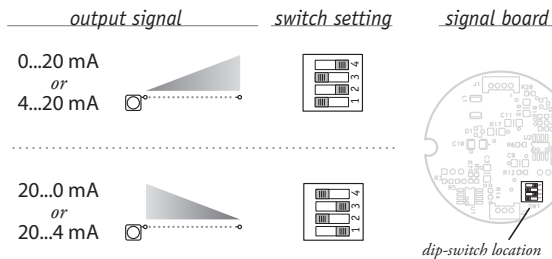

To gain access to the signal board, remove four Allen-Head Screws and remove end cover bracket.

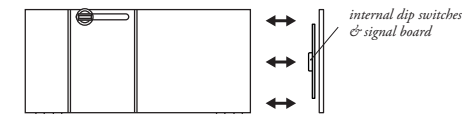

Caution! Do Not Remove Spring-Side End Cover
Removing spring-side end cover could cause spring to become unseated and permanently damaged.