

3508 and 3504 Process Controllers

This instrument is intended for permanent installation, for indoor use only, and to be enclosed in an electrical panel.

Select a location where minimum vibrations are present and the ambient temperature is within 0 and 50°C (32 and 122°F).

The instrument can be mounted on a panel up to 15mm thick.

To assure IP65 and NEMA 12 front protection, use a panel with smooth surface texture.

Please read the safety information before proceeding and refer to the EMC Booklet part number HA025464. For details not covered in this guide a 3500 Engineering Manual part no. HA027988 is available. These documents may be downloaded from www.eurotherm.co.uk.

Parts Supplied and Dimensions

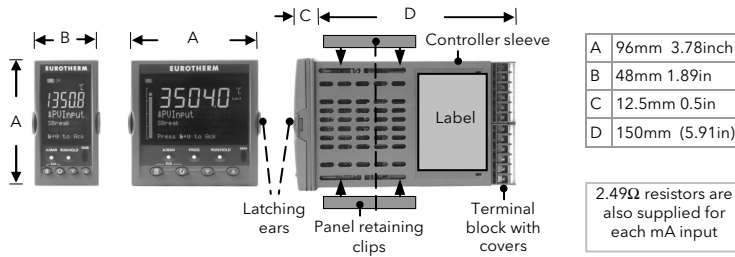

Instrument Terminals

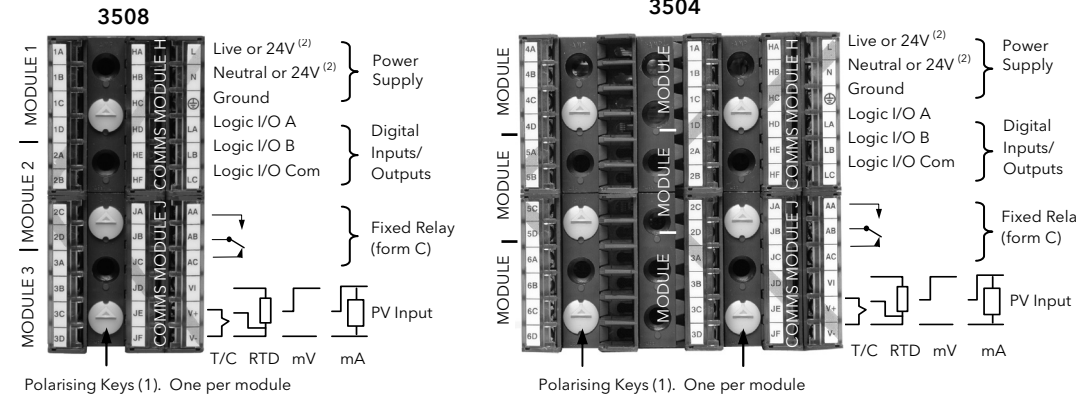

(1) Polarisising keys are intended to prevent modules, not supported by this controller, from being fitted. Supported modules are defined by the order code - the arrow on the polarising key points in the upward direction when these are fitted. An example of an unsupported module is an unisolated module (coloured red) from a 2400 series controller. It is possible to fit such a module but it is the users responsibility to ensure that it is safe to install it in the particular application. When this has been verified the polarising key may be adjusted with a screwdriver to point in the down direction.

Wiring Wire Sizes

The screw terminals accept wire sizes from 0.5 to 1.5 mm (16 to 22AWG) and should be tightened to 0.4Nm (3.5lb in). Hinged covers prevent hands or metal making accidental contact with live wires.

Installation

1. Cut out the panel to the size shown.

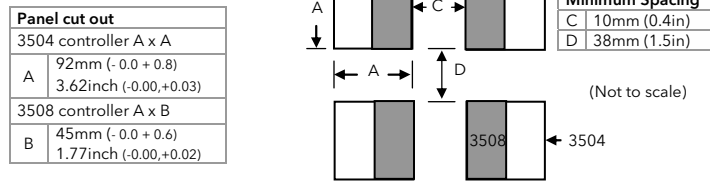

- Fit the IP65 sealing gasket behind the front bezel of the instrument
- Insert the instrument in its sleeve through the cut-out.
- Spring the panel retaining clips into place. Secure the instrument in position by holding it level and pushing both retaining clips forward.
- Peel off the protective cover from the display

If the panel retaining clips subsequently need removing, they can be unhooked from the side with either your fingers or a screwdriver.

To Remove the Controller from its Sleeve

Ease the latching ears outwards and pull the controller forward. When plugging back in ensure that the latching ears click into place to maintain the IP65 sealing

Standard Connections

These are connections which are common to all instruments in the range.

PV Input (Measuring Input)

- Run input wires separate from power cables
- When shielded cable is used, it should be grounded at one point only
- Any external components (such as zener barriers, etc) connected between sensor and input terminals may cause errors in measurement due to excessive and/or un-balanced line resistance or possible leakage currents
- This input is not isolated from logic I/O A and logic I/O B

Thermocouple or Pyrometer Input

- Use the correct type of thermocouple compensating cable, preferably shielded, to extend wiring
- It is not recommended to connect two or more instruments to one thermocouple

RTD Input

- The resistance of the three wires must be the same
 - The line resistance may cause errors if it is greater than 22Ω
- Note 1: The RTD wiring is not the same as 2400 series instruments. It is the same as 26/2700 series
- Note 2: For 2-wire this is a local link

Linear Input V, mV and High Impedance V

- mV range ±40mV or ±80mV
- High level range 0 - 10V
- High Impedance mid level range 0 - 2V. Used for zirconia probe oxygen input.
- A line resistance for voltage inputs may cause measurement errors

Linear Input mA

- For mA input connect the 2.49Ω resistor supplied across the input terminals
- The resistor supplied is 1% accuracy 50ppm temperature coefficient
- A resistor 0.1% accuracy 15ppm resistor can be ordered as a separate item. Part No. SUB35/ACCESS/249R.1

Built in Relay (AA)

- Relay shown in de-energised state
- Isolated 240Vac
- Relay rating: Max: 264Vac 2A resistive; min: 1V, 1mAdc to provide sufficient whetting current.
- Relay shown in de-energised state

Digital I/O

These terminals may be configured as logic inputs, contact inputs or logic outputs in any combination. It is possible to have one input and one output on either channel.

The Digital IO is not isolated from the PV input. The controller is designed to operate normally if the input sensor is connected to 240Vac, but in this case these terminals will be at this potential.

Logic Inputs

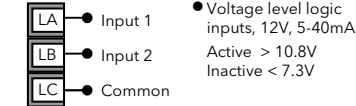

Contact Closure Inputs

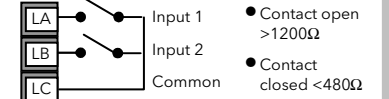

Digital (Logic) Outputs

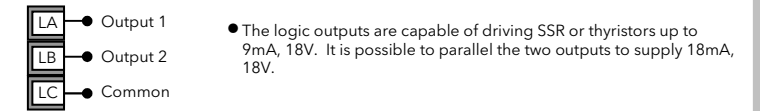

The fixed digital logic outputs may be used to power remote 2 wire transmitters. The fixed digital I/O are, however, not isolated from the PV input circuit, so this does not allow the use of 3 or 4 wire transmitters. An isolated module must be used for the 3 and 4 wire types.

Digital (Logic) Outputs used to power a remote 2 wire transmitter.

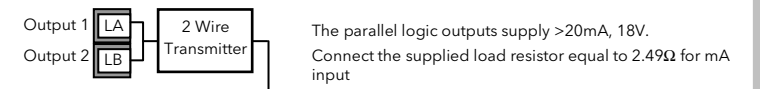

Digital (Logic) Output modules used to power remote 3 or 4 wire transmitters.

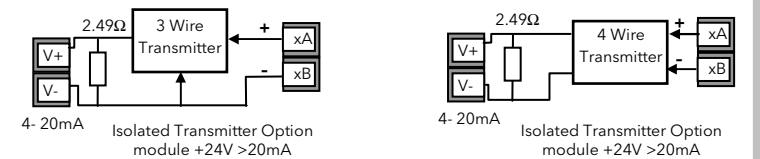

Plug in I/O Module Connections

Plug in I/O modules can be fitted in three positions in the 3508 and six positions in 3504. The positions are marked Module 1, 2, 3, 4, 5, 6. With the exception of the Analogue Input module, any other module listed in this section, can be fitted in any of these positions. To find out which modules are fitted check the ordering code printed on a label on the side of the instrument. If modules have been added, removed or changed it is recommended that this is recorded on the instrument code label.

Relay (2 pin) and Dual Relay Module

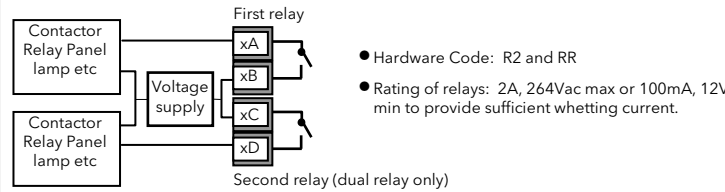

Change Over Relay

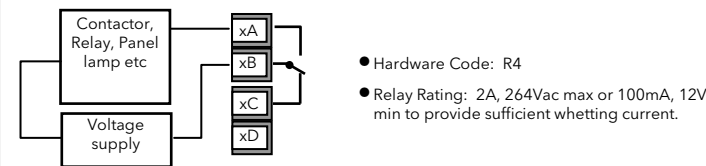

Triple Logic and Isolated Single Logic Output

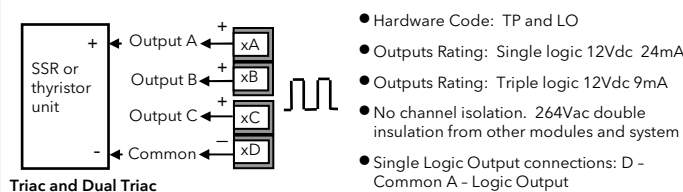

Triac and Dual Triac

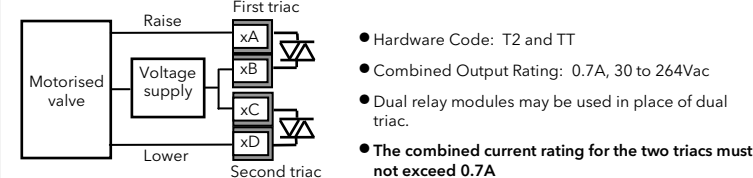

For module functionality see 'Quick Code'.

The function of the connections varies depending on the type of module fitted in each position and this is shown below.

Note: The order code and terminal number is pre-fixed by the module number (x). For example, Module 1 is connected to terminals 1A, 1B, 1C, 1D; module 2 to 2A, 2B, 2C, 2D, etc.

- All modules are isolated 240Vac CATII.

Snubbers

Snubbers are used to prolong the life of relay contacts and to reduce interference when switching inductive devices such as contactors or solenoid valves. The fixed relay (terminals AA/AB/AC) is not fitted internally with a snubber and it is recommended that a snubber be fitted externally. If the relay is used to switch a device with a high impedance input, no snubber is necessary.

All relay modules are fitted internally with a snubber since these are generally required to switch inductive devices. However, snubbers pass 0.6mA at 110V and 1.2mA at 230Vac, which may be sufficient to hold on high impedance loads. If this type of device is used it will be necessary to remove the snubber from the circuit.

The snubber is removed from the relay module as follows:-

- Unplug the controller from its sleeve
- Remove the relay module
- Use a screwdriver or similar tool to snap out the track.

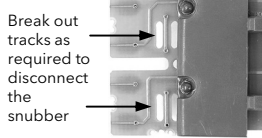

Dual DC Output (Slots 1, 2 and 4 only)

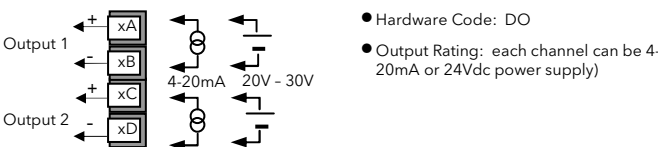

High Resolution DC Retransmission & Transmitter Power Supply (Slots 1, 2 and 4 only)

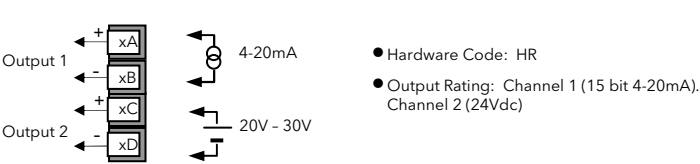

Plug in I/O Module Connections (continued)

DC Control

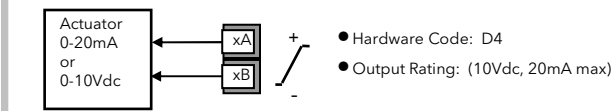

DC Retransmission

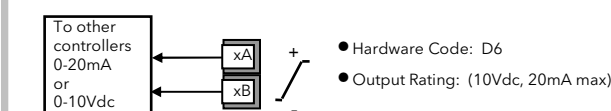

Triple Logic Input

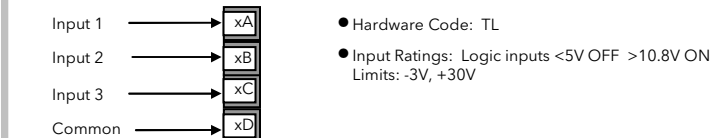

Triple Contact Input

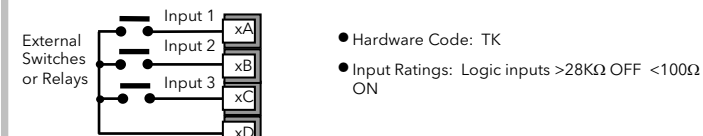

Potentiometer Input

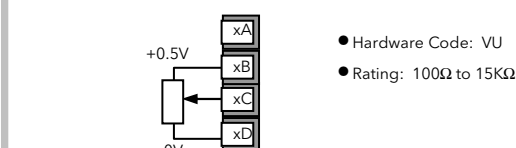

24V Transmitter Power Supply



Transducer Power Supply

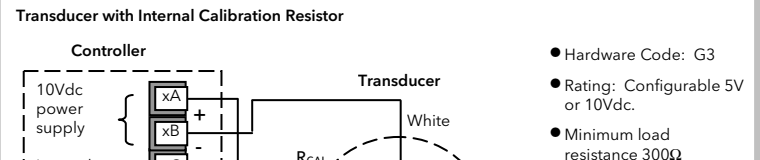

Transducer with External Calibration Resistor

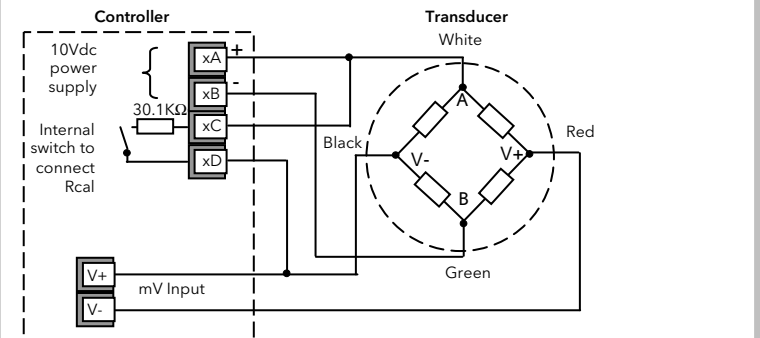

Switch On

If the Controller is new and has not previously been configured it will start up showing the 'Quick Start' codes. This is a built in tool which enables you to configure the input type and range, the output functions and alarms.



Incorrect configuration can result in damage to the process and/or personal injury and must be carried out by a competent person authorised to do so. It is the responsibility of the person commissioning the instrument to ensure the configuration is correct.

To Configure Parameters in Quick Start Mode

With 'QckStart' selected, press to scroll through a list of parameters.

Edit the parameters using or .

When the required choice is selected a brief blink of the display indicates that it has been accepted.

The first parameter is 'Units'.

This parameter is associated with Loop 1 'LP1' and resides in the 'PV Input' list as shown.



Continue setting up the paras presented until the 'Finished' view is displayed.

If all parameters are set up as required press or to select 'Yes'.

The loop(s) are set to Auto on exit from Quick Start and the controller re-starts in operator level 2.

The 'HOME' display is shown - see 'Normal Operation'.

If you wish to edit parameters again do not select 'Yes' but continue to press .

All available parameters are shown in the following tables.

Quick Start Parameters - Fixed Build

Parameters shown in **bold** are defaults.

Group	Parameter	Value	Availability
LP1 PV Input	Units Engineering units for the PV. (C, F, K options change the displayed units)	C, F, K V, mV, A, mA, pH, mmHg, psi, Bar, mBar, %RH, %, mmWG, inWG, inWW, Ohms, PSIG, %O ₂ , PPM, %CO ₂ , %CP, %/sec, Vacuum, sec, min, hrs, None	Always
LP1 PV Input	Resolution Decimal point position for the PV	XXXXX , XXXX.X, XXX.XX, XX.XXX, X.XXXX	Always
LP1 PV Input	Range Type To select the linearisation algorithm required and the input sensor.	Thermocouple: J, K, L, R, B, N, T, S, PL2, C , CustC1(2&3) RTD: Pt100 Linear: 0-50mV, 0-5V, 1-5V, 0-10V, 2-10V, 0-20mA, 4-20mA	Always
LP1 PV Input	IO Type Only shown if custom curve is selected	Thermocpl, RTD, Pyrometer, mV40, mV80, mA, Volts, HIZVolts, Log10	
LP1 PV Input	Range High/Low Max /min. display range and SP limits	Depends on Range type selected. Default 1372/-200	Always
LP1 Loop	Loop 1 Channel 1, control type (normally Heat)	PID , VPU, VPB, Off, OnOff	Always
LP1 Loop	Loop 2 Channel 2, control type (normally Cool)	PID , VPU, VPB, Off , OnOff	Always
LP2 PV Input	Source Defines where the PV input is wired to	None , FixedPV, Module6 (Module6 is available only if an analogue input module is fitted).	If a dual loop controller
The LP1 parameters listed above are repeated for LP2 if the LP2 PV Input is configured.			
Init LgcIO LA	Logic function (input or output) To configure the function of Logic IO which can be an output or an input.	Not Used , Lp1 Ch1, Lp1 Ch2, Lp2 Ch1, Lp2 Ch2, Alarm1 to 8, AnyAlarm, NewAlarm, ProgEvt1 to 8, LP1SBrkOP, LP2SBrkOP*, LPsSBrk*, (outputs) LP1 A-M, LP1 SPsel, LP2 A-M, LP2 SPsel, AlarmAck, ProgRun, ProgReset, ProgHold (Inputs)	[Note 1] [Note 2] * LP2 and LPs (both loops) only shown if the second loop is configured. Programmer options only available if the controller is a programmer/controller.
	Min OnTime (if configured as a control OP)	Auto , or 0.01 to 150.00	[Note 2] [Note 3]
The above two parameters are repeated for the LB Logic I/O (LgcIO LB)			
Init RlyOP AA	AA Relay output function This relay is always fitted.	Not Used , Lp1 Ch1, Lp1 Ch2, Lp2 Ch1, Lp2 Ch2, Alarm 1 to 8, Any Alarm, New Alarm, ProgEvt1 to 8, LP1SBrkOP, LP2SBrkOP*, LPsSBrk*.	Always if the instrument is ordered as a programmer/controller. [Note 4]
Init RlyOP AA	AA Relay Min OnTime	Auto , or 0.01 to 150.00	[Note 2] [Note 3]
Note 1 Parameters only appear if the function has been turned on, eg If 'Control Channel 1' = 'Off', 'Chan 1' does not appear in this list. When a control channel is configured for valve positioning, LgcIO LA and LgcIO LB act as a complementary pair. If, for example, Chan 1 is connected to LgcIO LA (valve raise) then LgcIO LB is automatically set to Chan 1 (valve lower). This ensures the valve is never raised and lowered simultaneously. The same complementary behaviour also applies to dual output modules and channels A and C of triple output modules			
Note 2 If any input function, for example Chan 1, is connected to another input it will not appear in this list			
Note 3 Is available if the Control Channel is not On/Off and is allocated to the LA, LB or AA output as applicable			
Note 4 For valve position control Chan 1 or Chan 2 will not appear in this list. Valve position outputs can only be dual outputs such as LA and LB or dual relay/triac output modules			

Quick Start Parameters - Plug in I/O Modules

The controller automatically displays parameters applicable to the module fitted - if no module is fitted in a slot then it does not appear in the list.

Each module can have up to three inputs or outputs. These are shown as A, B or C after the module number and this corresponds to the terminal numbers on the back of the instrument. If the I/O is single only A appears. If it is dual A and C appears if it is triple A, B and C appear.

Note: If an incorrect module is fitted the message 'Bad Ident' will be displayed.

Module type	Parameter	Value	Availability
Change over relay (R4) 2 pin relay (R2) Triac output (T2) Dual Relay (RR) Dual triac output (TT)	Relay (Triac) function	Not Used All parameters the same as RlyOP AA, including Min OnTime if the OP is a relay	Always (if the module is fitted)
Single Logic Output (LO) Triple Logic Output (TP)	Logic Out function	Not Used All parameters the same as RlyOP AA	Always (if the module is fitted)
DC Output (D4) DC Retransmission (D6)	DC Output function	Not Used Module fitted but not configured LP1/2 Ch1/2OP Loop 1/2 Channel 1/2 control output LP1/2 SP Tx Loop 1/2 setpoint retransmission LP1/2 PV Tx Loop 1/2 PV retransmission LP1/2 ErrTx Loop 1/2 error retransmission LP1/2 PwrTx Loop 1/2 output retransmission Range Type 0-5V, 1-5V, 1-10V, 2-10V, 0-20mA, 4-20mA Display High/low 100.0/0	Always (if the module is fitted). Note: If a Dual DC Output module is fitted, it cannot be configured using the Quick Start Code. To configure this module refer to the Engineering Manual part no. HA027988.
Triple Logic Input (TL) Triple Contact Input (TK)	Logic In function	Not Used Module fitted but not configured LP1/2 A-M Loop 1/2 Auto/manual LP1/2 SPsel Loop 1/2 SP select LP1/2 AltSP Loop 1/2 Alternative SP select AlarmAck Alarm acknowledge ProgRun/Reset/Hold Programmer run/reset/hold	A function can only be allocated to one input. eg if AlarmAck is configured on X*A it is not offered for the other inputs * is the module number. LP2 does not appear if loop 2 is not configured.
Analogue Input (AM)	Analogue IP function	Not Used Module fitted but not configured LP1/2 AltSP Loop 1/2 alternative setpoint LP1/2 OPH/L Loop 1/2 remote OP power max/min LP1/2 V1/2Pos To read valve position from the feedback potentiometer loop 1/2	LP1/2 V1Pos and LP1/2 V2Pos only appear if Loop 1 or 2 and the control channel 1 or 2 is set to VPB. Alt/SP does not appear if the programmer option is supplied. LP2 does not appear if loop 2 is not configured.
	Range Type	Thermocouple: J, K, L, R, B, N, T, S, PL2, C. RTD: Pt100 Linear: 0-50mV, 0-5V, 1-5V, 0-10V, 2-10V, 0-20mA, 4-20mA	Not shown if analogue IP function not used
	Display High/low	100.0/0.0	These parameters only appear for Linear Range
Potentiometer Input (VU)	Pot Input function	Not Used Module fitted but not configured LP1/2 AltSP Loop 1/2 Alternative setpoint LP1/2 OPH/L Loop 1/2 output power maximum/ minimum LP1/2 V1/2Pos To read valve position from the feedback potentiometer loop 1/2	LP1/2 V1Pos and LP1/2 V2Pos only appear if Loop 1 or 2 and the control channel 1 or 2 is set to VPB. Alt/SP does not appear if the programmer option is supplied. LP2 does not appear if loop 2 is not configured.
Transducer Power Supply (G3)	TdcrPSU function	5 Volts or 10 Volts	Always (if the module is fitted)
Transmitter power supply (MS)	No parameters. Used to show the ID of the module if fitted		

Quick Start Parameters - Alarms

Parameters shown in **Bold** are defaults.

Group	Parameter	Value	Availability
Init Alarm 1 to 8	Type	None Abs High/Low Absolute high/low Dev High/ Low/ Band Deviation high/ low/ band	Always
Init Alarm 1 to 8	Source	None Not connected PV Input Connected to main process variable does not appear if Alarm Type = Deviation LP1/2 PV Connected to Loop 1/2 process variable Module1 - Module6 Connected to an analogue input module and only of the Alarm Type is not a deviation alarm	Always if Type ≠ None PV Input and ModX lp do not appear if Type = Deviation
Init Alarm 1 to 8	Setpoint	To adjust the alarm threshold within the range of the source.	Always if Type ≠ None
Init Alarm 1 to 8	Latch	None No latching Auto Automatic latching The alarm continues to be active until both the alarm condition is removed AND the alarm is acknowledged. The acknowledgement can occur BEFORE the condition causing the alarm is removed. Manual Manual latching The alarm continues to be active until both the alarm condition is removed AND the alarm is acknowledged. The acknowledgement can only occur AFTER the condition causing the alarm is removed. Event Alarm beacon does not light but any output associated with the event will activate and a scrolling message will appear.	Always if Type ≠ None
Finished	Exit	No Continue back around the quick configuration list Yes Go to normal operation. The loop(s) are set to Auto on exit from quickstart mode and the controller re-starts in Level 2.	

To Re-enter Quick Start Mode

If you have exited from Quick Start mode (by selecting 'Yes' to the 'Finished' parameter) and you need to make further changes, the Quick start mode can be entered again at any time.

- Hold down then power up the controller. Keep this button pressed until the 'Startup' - 'Goto QckStart' screen is displayed.
- Press to enter the quick start list. You will then be asked to enter a passcode.
- Use or to enter the passcode - default 4. If an incorrect code is entered the display reverts to the 'Quick Start' view.

It is then possible to repeat the quick configuration as described previously.

Note: The Quick Start view contains two additional parameters - 'Cancel' and 'Config'.

Select **Cancel** to revert to normal operating mode.

Config will allow full configuration mode to be entered (after entering the correct pass code). Configuration is described in the Engineering Manual HA027988.

Normal Operation

Switch on the controller. Following a brief self-test sequence, the controller will start up in AUTO mode and show the 'HOME' display in Operator Level 2 (following Quick Start).

If the controller is configured as a dual loop instrument the start up view shows a summary of the two loops.

Note: Views shown in this guide are for 3504 and represent typical examples.

Operator Buttons

A/MAN This button can be disabled	Toggles the selected loop between Auto and Manual operation. In Manual the controller output power is adjusted by the user using buttons. The input sensor is still connected and reading the PV but the control loop is open. 'MAN' will be indicated. In Auto the controller automatically adjusts the output to maintain control, ie the loop is closed. The controller will power up in the mode it was in when it was powered down.
PROG	To select the programmer summary page
RUN/HOLD This button can be disabled	Press once to select a program. Press again to run the selected program. 'RUN' will be indicated in the top banner of the display. Press again to hold a program. 'HLD' will be indicated Press and hold for at least two seconds to reset a program. 'RUN' will flash at the end of a program 'HLD' will flash during holdback
+	'ACK'. Press these buttons together to acknowledge an alarm.
	Press to select new PAGE headings
	Press to select a new parameter in the page
	Press to decrease an analogue value, or to change the state of a digital value.
	Press to increase an analogue value, or to change the state of a digital value

Shortcut Key Presses

Backpage	Press followed by . With held down continue to press or to scroll page headers backwards or forwards.
Backscroll	When in a list of parameters, press followed by . With held down continue to press or to scroll parameters backwards or forwards.
Jump to HOME display	Press +

Typical HOME Display

Beacons →
Process Variable (PV) →
Loop 1 →
Output Loop 1 →
Output Loop 2 →
Auto/Manual Loop2 →
Operator buttons →

← Units (if configured)
← Current access level Lev1; Lev2; or Lev3 (3504 only)
← Setpoint (SP) Loop 1
← Process Variable (PV) Loop 2
← Setpoint (SP) Loop 2

Press to scroll through further parameters including programmer status details

If the controller is configured as a dual loop the HOME displays will vary as shown here:-



Beacons	Description
OP1	Illuminates when output 1 is ON (normally heating)
OP2	Illuminates when output 2 is ON (normally cooling or alarm)
MAN	Illuminates when manual mode active. If the HOME display is showing the dual loop overview, MAN illuminates if Loop 1 is in manual. If the Loop 1 or Loop 2 overviews are being displayed MAN applies to the loop being displayed.
REM	Illuminates when alternative setpoint is active
SPX	Illuminates when setpoint 2 is active
ALM	If an alarm occurs the red alarm beacon flashes together with a message showing the source of the alarm, for example 'AnAlm1 - Abs Hi' (the latter can also be a customised message). When acknowledged the alarm message disappears. If the alarm condition is still present the beacon lights continuously. For non-latched alarms it will extinguish when the alarm is cleared.
RUN	Illuminates when the programmer running - flashing indicates End
HLD	Illuminates when the programmer is in Hold (frozen)
J	Flashes when J Channel digital communications is active
H	Flashes when H Channel digital communications is active
IR	On when infra red communications is enabled and flashes when infra red communications is active

To Set The Required Temperature (Setpoint)

In the view above, press or to lower or raise the setpoint value of Loop 1.

The new setpoint is accepted when or is released and is indicated by a brief flash of the setpoint value.

To change Loop 2 setpoint, press . Loop 2 SP value is preceded by . Press or as above to change the value.

A momentary press of either button will show the setpoint in use, e.g. SP1.

Plug in I/O Module Connections (continued)

Analogue Input (T/C, RTD, V, mA, mV) Slots 1, 3, 4 & 6 only

- Hardware Code: AM
- Isolated output 240Vac CATII

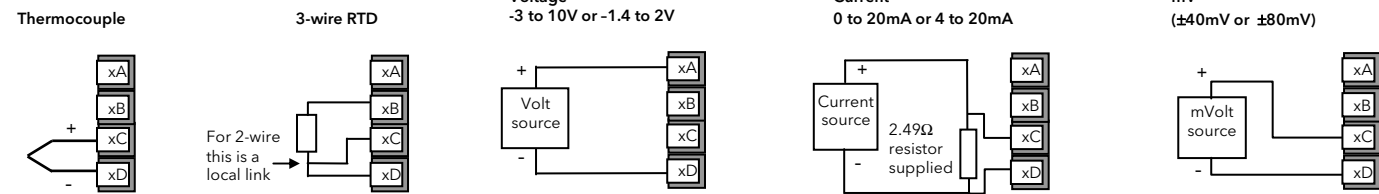

Analogue Input (Zirconia Probe)

- The temperature sensor of the zirconia probe can be connected to the Fixed PV input, terminals V+ and V-, or to an Analogue Input module, terminals C & D. The voltage source is connected to an Analogue Input module, terminals A & D.

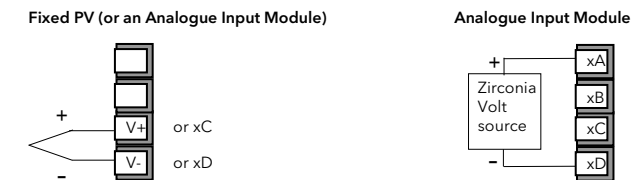

Zirconia Probe Screening Connections

The zirconia sensor wires should be screened and connected to the outer shell of the probe if it is situated in an area of high interference.

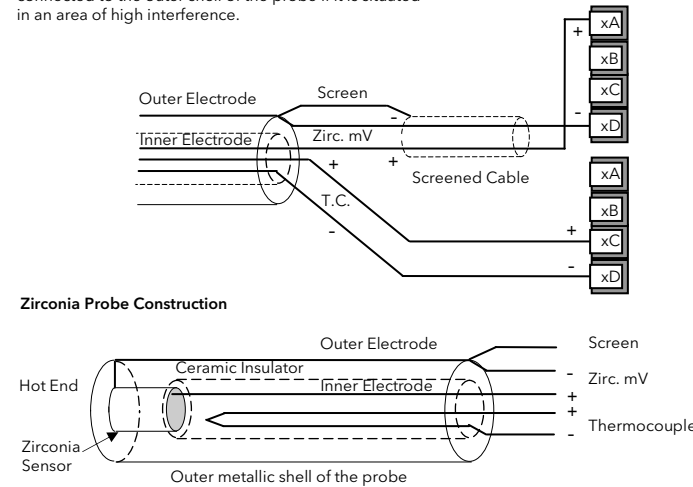

Digital Communications Connections

Digital Communications modules can be fitted in both H and J positions. The connections being available on HA to HF and JA to JF depending on the position in which the module is fitted. The two positions could be used, for example, to communicate with 'iTools' configuration package on one position, and to a PC running a supervisory package on the second position.

Communications protocols may be Modbus, ElBisynch, DeviceNet, Profibus or Modbus TCP. Broadcast and Modbus Master Communications (firmware versions 2.90 onwards) is also available. The master may be connected to the slaves using EIA232, EIA485 or EIA422 as shown below. Please refer to the Engineering Manual HA027988 for further details.

Note:- In order to reduce the effects of RF interference the transmission line should be grounded at both ends of the screened cable. However, if such a course is taken care must be taken to ensure that differences in the earth potentials do not allow circulating currents to flow, as these can induce common mode signals in the data lines. Where doubt exists it is recommended that the Screen (shield) be grounded at only one section of the network as shown in all of the following diagrams.

A further description of Modbus and ElBisynch communications is given in 2000 series Communications Handbook HA026230, which can be downloaded from www.eurotherm.co.uk.

- Digital communications modules isolated 240Vac CATII

Modbus (H or J Module) or ElBisynch

EIA232 Connections

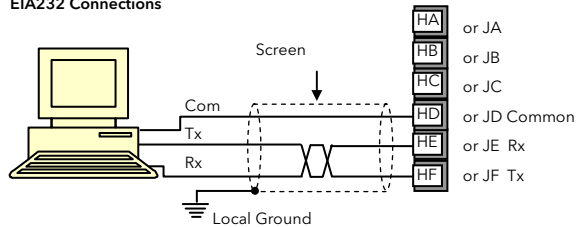

Broadcast and Modbus Master Communications Connections

Note: EIA422, EIA485 4-wire or EIA232

Rx and Tx connections in the master are wired to Tx and Rx connections of the slave respectively

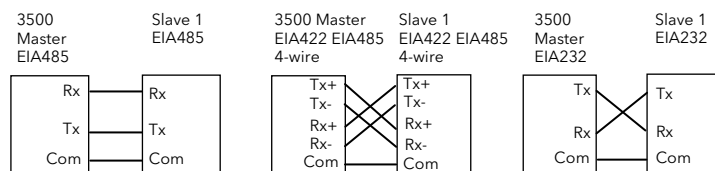

EIA422/EIA485 5-Wire Connections

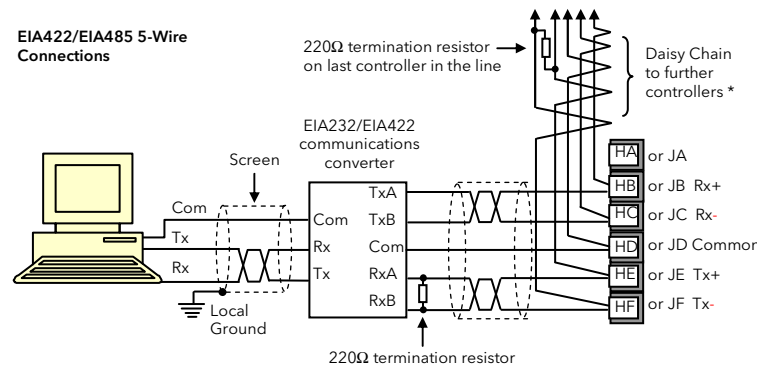

EIA485 3-Wire Connections

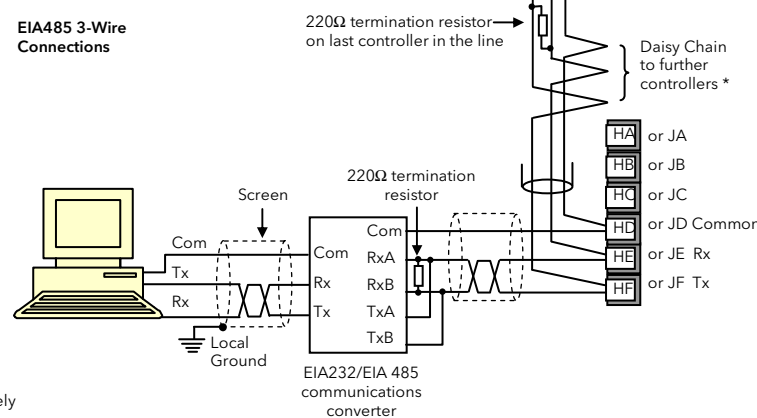

⊗ = Twisted pairs

* The use of bootlace ferrules may be an aid to wiring where two wires are to be connected to the same terminal

The KD485 communications converter is recommended for interfacing to EIA 485. This unit is also used to buffer an EIA 485 network when it is required to communicate with more than 32 instruments on the same bus, and may also be used to bridge 2-wire EIA485 to 4-wire EIA 422.

Controller Power Supply

Ensure that you have the correct supply for your controller. Before connecting the instrument to the power line, make sure that the line voltage corresponds to the description on the identification label.

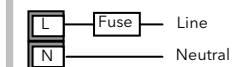

- High voltage supply: 100 to 230Vac, ±15% 48 to 62 Hz

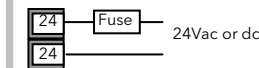

- Low voltage supply: 24Vac -15% +10%, 48 to 62Hz 24Vdc -15% +20%

- For supply connections use 16SWG or larger wires rated for at least 75°C.
- Use copper conductors only.
- For 24V the polarity is not important.
- The power supply input is not fuse protected. This should be provided externally. Recommended external fuse ratings are as follows:-
For 24 V ac/dc, fuse type: T rated 4A 250V
For 100-230Vac, fuse type: T rated 1A 250V.

Safety requirements for permanently connected equipment state:

- A switch or circuit breaker shall be included in the building installation
 - It shall be in close proximity to the equipment and within easy reach of the operator
 - It shall be marked as the disconnecting device for the equipment.
- Note: a single switch or circuit breaker can drive more than one instrument.

Back up Battery

This instrument is fitted with a back up battery which should be changed between 6 and 10 years of use.

A record of instrument configurations or, preferably, a clone file should be maintained. This can be re-loaded following a battery change or other maintenance. The battery is not serviceable: contact your local service centre to make suitable arrangements. For further information see User Manual HA027988 at www.eurotherm.co.uk.

Ethernet (Modbus TCP)

The Ethernet module can only be fitted in the H slot - terminals HA to HF. With this option a special cable assembly is also supplied. This cable must be used since the magnetic coupling is contained within the RJ45 connector. It consists of an RJ45 connector (socket) and a termination assembly which must be connected to terminals HA to HF.

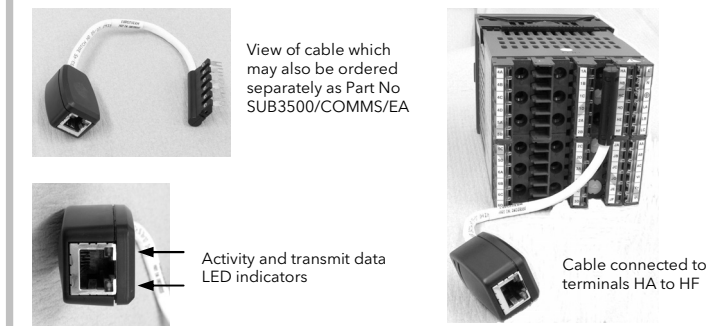

I/O Expander

An I/O expander (Model No 2000IO) can be used with 3500 series controllers to allow the number of I/O points to be increased by up to a further 20 digital inputs and 20 digital outputs. Data transfer is performed serially via a two wire interface module (order code EX) which is fitted in digital communications slot J.

A description of the IO Expander is given in handbook HA026893 which can be downloaded from www.eurotherm.co.uk.

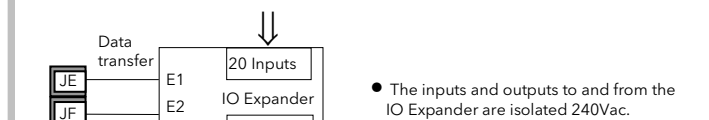

- The inputs and outputs to and from the IO Expander are isolated 240Vac.

DeviceNet Wiring

A description of Profibus is given in the Profibus Communications Handbook Part No HA026290 which can be downloaded from www.eurotherm.co.uk.

Further information is available in the DeviceNet Communications Handbook Part No HA027506 which can be downloaded from www.eurotherm.co.uk. This table shows standard cable connections.

Controller Terminal	CAN Label	Wire Colour	Description
HA	V+	Red	DeviceNet network power positive terminal. Connect the red wire of the DeviceNet cable here. If the DeviceNet network does not supply the power, connect to the positive terminal of an external 24 Vdc power supply.
HB	CAN_H	White	DeviceNet CAN_H data bus terminal. Connect the white wire of the DeviceNet cable here.
HC	SHIELD	None	Shield/Drain wire connection. Connect the DeviceNet cable shield here. To prevent ground loops, the DeviceNet network should be grounded in only one location.
HD	CAN_L	Blue	DeviceNet CAN_L data bus terminal. Connect the blue wire of the DeviceNet cable here.
HE	V-	Black	DeviceNet network power negative terminal. Connect the black wire of the DeviceNet cable here. If the DeviceNet network does not supply the power, connect to the negative terminal of an external 24 Vdc power supply.
HF			Connect to instrument earth

Profibus

Example Profibus Wiring

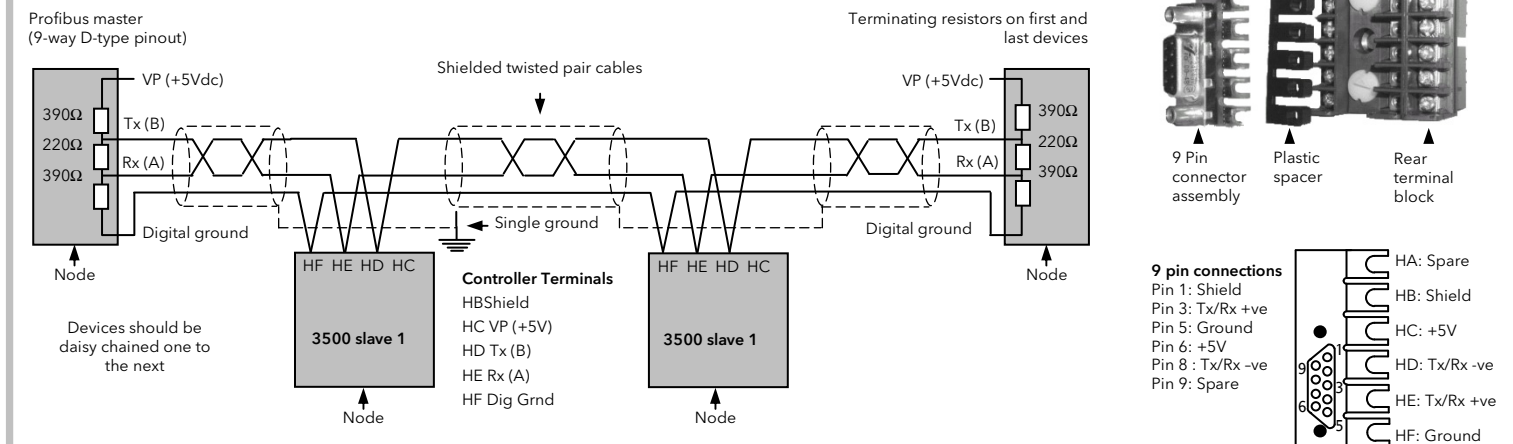

To Select Manual Operation

Press **A/MAN** (A/MAN) button.

If two loops are enabled and the dual loop overview is being displayed, pressing the A/MAN button will toggle loop 1 between Auto and Manual. The beacon 'MAN' will light and the indication of output power is preceded by **Man**.

Press and hold **▲** or **▼** to decrease or increase the output power.

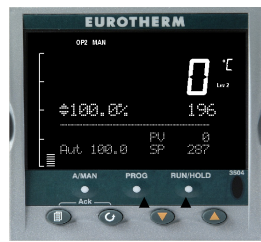

The MAN beacon illuminates

The SP line changes to show output demand.

To switch loop 2 between Auto and Manual, press **▲** to scroll into the loop 2 section, then press A/MAN.

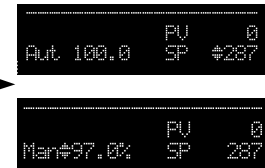

If loop 1 overview is being displayed, press the A/MAN button to toggle loop 1 between Auto and Manual

If loop 2 overview is being displayed, press the A/MAN button to toggle loop 2 between Auto and Manual.

If any other overview is being displayed, the first press of the A/MAN button will select the dual loop overview and the action is as described above.

The output power changes continuously when **▲** or **▼** is pressed

Summary Pages

If configured these are shown in the lower alpha-numeric message centre. They list typical operating parameters for different features of the controller as shown in the Navigation Diagram below:

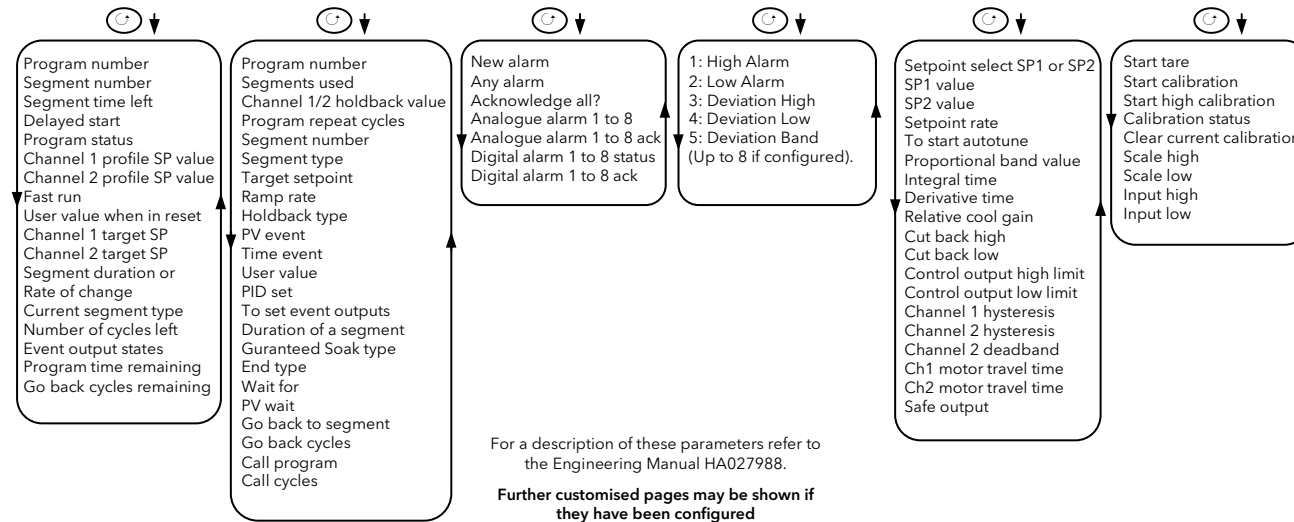
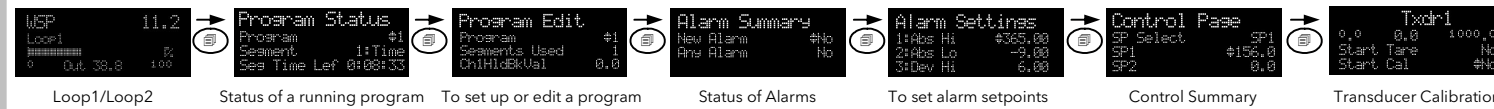

Example: To Create or Edit a Program

This example shows how the operator buttons are used to set up a program. The principle is the same for all features. A program can only be edited when it is in Reset or Hold.

Select a program	Press ⊙ to select the 'Program Edit' page Press ▲ or ▼ to select the program number
Set up a holdback value *	Press ▲ to select 'Ch1/2HldBkVal' Press ▲ or ▼ to set the value
Set up the number of times a program repeats *	Press ▲ again to select 'Cycles' Press ▲ or ▼ to choose the number of cycles
Set up or edit a segment	Press ▲ to select 'Segment' Press ▲ or ▼ to choose the segment number
Set up the segment type	Press ▲ to select 'Segment Type' Press ▲ or ▼ to choose the segment type
The parameters which follow depend on the segment type chosen.	
Set up the value of SP required at the end of the segment	Press ▲ to select 'Target SP' for Ch1 and Ch2. Press ▲ or ▼ to choose the value
Set up the segment time	Press ▲ to select 'Duration'. Press ▲ or ▼ to choose the value
Set up 'Holdback Type' *	Press ▲ to select Ch1/2HldBck Type'. Press ▲ or ▼ to choose the value
Set up which events operate in the segment *	Press ▲ to select 'Event Outs'. Press ▲ or ▼ to turn the event on or off.

* These parameters are only shown if the feature has been configured. See the Engineering manual HA027988 for further information.

Repeat the above procedure for further segments required in the program. The final segment should be configured as 'End' You can then set up the action required at the end of the program. This may be 'Dwell', 'Reset' or 'SafeOP'.

♦ The following choices are available, depending on programmer type. For example SyncAll offers Wait, Time and End only:-

Rate	Rate of change of setpoint
Time	Time to target
Dwell	Soak at constant setpoint
Step	Step change to new setpoint
Wait	Wait for pre-determined condition
GoBack	Repeat previous segments
Call	Insert a new program
End	Final segment

Holdback freezes the program if the process value (PV) does not track the setpoint (SP) by more than a user defined amount. The instrument will remain in HOLDBACK until the PV returns to within the requested deviation from setpoint. The display will flash the HOLD beacon.

Holdback Type may be selected from:-

Off	No holdback
Band	Deviation high & low
High	Deviation high
Low	Deviation low

Example: To Select and Run a Program

This example assumes the program has been entered as described.

Press ⊙	
Select a program	Press ▲ or ▼ to choose the program number to be run
Run the selected program	Press ⊙ again
Hold a program	Press ⊙
Reset a program	Press and hold ⊙ for at least 3 seconds

Alternatively, run, hold or reset a program by scrolling to 'Program Status' using **▲** and select 'Run', 'Hold' or 'Reset' using **▲** or **▼**.

The **PROG** button (3504 only) provides a short cut to the Program Status page from any view.

To inspect/change the status of a running program, press **⊙** to select the 'Program Status' list and **▲** to select parameters.

Access Levels

Parameters are available in deeper levels of access protected by different levels of security. **Lev1** and **Lev2** are intended for day to day operation. It is possible to configure a limited number of parameters in either level. **Lev3** provides a much greater access to parameters. Typically these are parameters used when commissioning a system. **Config**. To change the fundamental characteristics of the instrument. Each level (except 1) is protected by a security code. The security codes can be changed in Configuration level as described in the Engineering Handbook HA027988.

To Select an Access Level

Press and hold **⊙** until the display shows 'Access'.
Press **▲** or **▼** to 'Goto' the required access level
Press **▲** or **▼** to enter a security code. For level 2 the default is 2. When the correct pass code has been entered 'Pass' is displayed momentarily and the controller returns to the HOME display in the level of operation selected.
It is not necessary to enter a pass code when going from a higher level to a lower level.

Safety and EMC Information

This instrument is intended for industrial temperature and process control applications within the requirements of the European Directives on Safety and EMC. The information contained in this manual is subject to change without notice. While every effort has been made to ensure the accuracy of the information, your supplier shall not be held liable for errors contained herein.

⚠ The safety and EMC protection can be seriously impaired if the unit is not used in the manner specified. The installer must ensure the safety and EMC of the installation.

Safety. This instrument complies with the European Low Voltage Directive 2006/23/EC, by the application of the safety standard EN 61010.

Unpacking and storage. If on receipt, the packaging or unit is damaged, do not install but contact your supplier. If being stored before use, protect from humidity and dust in an ambient temperature range of -30°C to +75°C.

Electrostatic discharge precautions. Always observe all electrostatic precautions before handling the unit.

Service and repair. This instrument has no user serviceable parts. Contact your supplier for repair.

Cleaning. Isopropyl alcohol may be used to clean labels. Do not use water or water based products. A mild soap solution may be used to clean other exterior surfaces.

Electromagnetic compatibility. This instrument conforms with the essential protection requirements of the EMC Directive 2004/108/EC, by the application of a Technical Construction File. It satisfies the general requirements of the industrial environment defined in EN 61326.

Caution: Charged capacitors. Before removing an instrument from its sleeve, disconnect the supply and wait at least two minutes to allow capacitors to discharge. Avoid touching the exposed electronics of an instrument when withdrawing it from the sleeve.

Safety Symbols. Symbols used on the instrument have the following meaning:

⚠ Caution, refer to accompanying documents) **⊕** Protective Conductor Terminal

Installation Category and Pollution Degree. This unit has been designed to conform to BSEN61010 installation category II and pollution degree 2, defined as follows:-

Installation Category II (CAT II). The rated impulse voltage for equipment on nominal 230V supply is 2500V.

Pollution Degree 2. Normally only non conductive pollution occurs. However, a temporary conductivity caused by condensation must be expected.

Personnel. Installation must only be carried out by suitably qualified personnel

Enclosure of Live Parts. To prevent hands or metal tools touching parts that may be electrically live, the controller must be installed in an enclosure.

Caution: Live sensors. The controller is designed to operate if the temperature sensor is connected directly to an electrical heating element. However, you must ensure that service personnel do not touch connections to these inputs while they are live. With a live sensor, all cables, connectors and switches for connecting the sensor must be mains rated for use in 230Vac ±15% CATII.

Wiring. It is important to connect the unit in accordance with the data in this sheet ensuring that the protective earth connection is ALWAYS fitted first and disconnected last. Wiring must comply with all local wiring regulations, i.e. UK, the latest IEE wiring regulations, (BS7671), and USA, NEC Class 1 wiring methods.

⚠ Do not connect AC supply to low voltage sensor input or low level inputs and outputs.

Voltage rating. The maximum continuous voltage applied between any of the following terminals must not exceed 230Vac ±15%:

- relay output to logic, dc or sensor connections;

- any connection to ground.

The controller must not be wired to a three phase supply with an unearthed star connection. Under fault conditions such a supply could rise above 240Vac with respect to ground and the product would not be safe.

Conductive pollution. Electrically conductive pollution i.e. carbon dust, MUST be excluded from the enclosure in which the controller is installed. To secure a suitable atmosphere in conditions of conductive pollution, fit an air filter to the air intake of the enclosure. Where condensation is likely, include a thermostatically controlled heater in the enclosure.

Grounding of the temperature sensor shield. In some installations it is common practice to replace the temperature sensor while the controller is still powered up. Under these conditions, as additional protection against electric shock, we recommend that the shield of the temperature sensor is grounded. Do not rely on grounding through the framework of the machine.

Over Temperature Protection.

To prevent overheating of the process under fault conditions, a separate over-temperature protection unit should be fitted which will isolate the heating circuit. This must have an independent temperature sensor.

Note: Alarm relays within the unit will not give protection under all failure conditions.

Installation Requirements for EMC. To comply with European EMC directive certain installation precautions are necessary:-

- General guidance. Refer to *EMC Installation Guide*, Part no. HA025464.

- Relay outputs. It may be necessary to fit a suitable filter to suppress conducted emissions. Filter requirements depend on the type of load.

- Table top installation. If using a standard power socket, compliance with commercial and light industrial emissions standard is usually required. To comply with conducted emissions standard, a suitable mains filter must be installed.

Restriction of Hazardous Substances (RoHS)						
Product group	3500					
Table listing restricted substances						
Chinese						
限制使用材料一览表						
产品	铅	汞	镉	六价铬	多溴联苯	多溴二苯醚
印刷电路板组件	X	O	X	O	O	O
附属物	O	O	O	O	O	O
显示器	X	O	X	O	O	O
模块	X	O	X	O	O	O
O	表示该有毒有害物质在该部件所有均质材料中的含量均在SJ/T11363-2006标准规定的限量要求以下。					
X	表示该有毒有害物质至少在该部件的某一均质材料中的含量超出SJ/T11363-2006标准规定的限量要求。					
English						
Restricted Materials Table						
Product	Toxic and hazardous substances and elements					
3500	Pb	Hg	Cd	Cr(VI)	PBB	PBDE
PCBA	X	O	X	O	O	O
Enclosure	O	O	O	O	O	O
Display	X	O	X	O	O	O
Modules	X	O	X	O	O	O
O	Indicates that this toxic or hazardous substance contained in all of the homogeneous materials for this part is below the limit requirement in SJ/T11363-2006.					
X	Indicates that this toxic or hazardous substance contained in at least one of the homogeneous materials used for this part is above the limit requirement in SJ/T11363-2006.					
Approval						
Name:	Position:	Signature:	Date:			
Kevin Shaw	R&D Director	<i>KShaw</i>	24th July 2013			

Manufacturing Address

U.K. Worthing
Eurotherm Ltd

T (+44) 1903 268500

E info.eurotherm.uk@invensys.com.

www.eurotherm.co.uk

© Copyright Eurotherm Ltd™ 2013

Invensys, Eurotherm, the Eurotherm logo, Chessell, EurothermSuite, Mini8, Eyon, Eyris, EPower, EPack nanodac, piccolo, Foxboro, and Wonderware are trademarks of Invensys plc, its subsidiaries and affiliates. All other brands may be trademarks of their respective owners.

All rights are strictly reserved. No part of this document may be reproduced, modified or transmitted in any form by any means, neither may it be stored in a retrieval system other than for the purpose to act as an aid in operating the equipment to which the document relates, without the prior written permission of Invensys Eurotherm Limited.

Eurotherm Limited pursues a policy of continuous development and product improvement. The specifications in this document may therefore be changed without notice. The information in this document is given in good faith, but is intended for guidance only.

Eurotherm Limited will accept no responsibility for any losses arising from errors in this document.

Contact Information

Eurotherm Head Office

Faraday Close,

Durrington,

Worthing, West Sussex,

BN13 3PL

Sales Enquiries

T +44 (01903) 695888

F 0845 130 9936

General Enquiries

T +44 (01903) 268500

F 0845 265982

inven'sys
Eurotherm

Worldwide Offices
www.eurotherm.com/global



Scan for local contacts

