

INSTRUCTION MANUAL

NT935 ETH

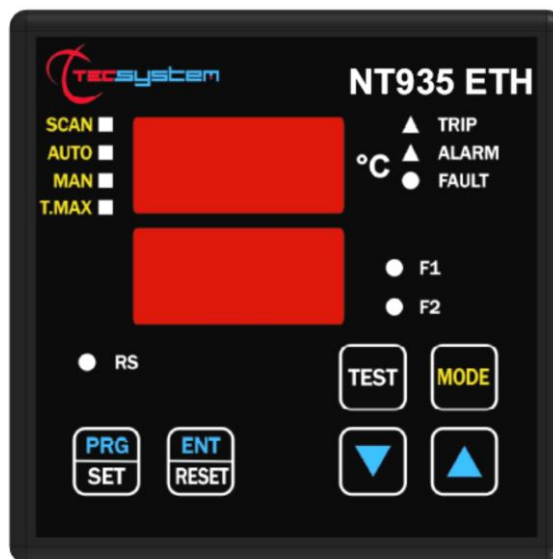

1MN0121 REV. 0



operates with ISO9001 certified quality system

TECSYSTEM S.r.l.
20094 Corsico (MI)
Tel.: +39-024581861
Fax: +39-0248600783

<http://www.tecsystem.it>

R. 1.6 01/08/19

ENGLISH

“Translations of the original instructions”

INTRODUCTION

First of all we wish to thank you for choosing to use a **TECSYSTEM** product and recommend you read this instruction manual carefully: You will understand the use of the equipment and therefore be able to take advantage of all its functions.

ATTENTION! THIS MANUAL IS VALID AND COMPLETE FOR THE NT935 ETH CONTROL UNIT

CONTENTS

	PAGE
1) SAFETY REQUIREMENTS	4
2) ACCESSORIES	5
3) TECHNICAL SPECIFICATIONS	6
4) FRONT PANEL	8
• DISPLAY	9
• OPERATING PROGRAM CONTROL	—
• NOTES ON SCAN AND MAN FUNCTIONS	—
• LED TEST	—
• ALARM RELAY TEST	—
• ALARM RELAY SILENCING	—
5) MOUNTING	10
6) ELECTRICAL CONNECTIONS	11
• NT935 ETH BACK	—
• POWER SUPPLY	12
• ALARMS AND VENTILATION	—
• FAULT AND RESET MESSAGE SEQUENCE	—
7) PROGRAMMING	13
• NT935 ETH	—
• PROGRAMMING NOTES	14
• TEMPERATURE SENSORS	15
• MEASUREMENT SIGNAL TRANSFER	—
• TEMPERATURE SENSOR DIAGNOSTICS	16
• VOTING FUNCTION	—
• PROGRAMMED DATA DIAGNOSTICS	—
• TEMPERATURE DIAGNOSTICS	—
• COOLING FAN CONTROL	17
• FAN TEST	—
• INTELLIFAN FUNCTION	—

	PAGE
8) ETHERNET MODBUS TCP OUTPUT	18
• INTRODUCTION TO THE ETHERNET MODULE	—
• OPERATING NOTES	—
• DATA TRANSMISSION	—
• NOTES ON ETHERNET ELECTRICAL CONNECTIONS	—
• FUNCTION CODE	—
• CODE 3(10).	—
• CODE 16(10).	—
• NOTES FOR REMOTE PROGRAMMING	19
• ERROR CODES	—
• UNACCEPTABLE DATA	—
• ILLEGAL DATA	20
• MODBUS MAPPING TABLE	—
9) FAIL SAFE FUNCTION	25
10) ETHERNET MODULE PARAMETER PROGRAMMING	26
• ETH0 CONNECTIONS	—
• TELNET ENABLING	27
• TELNET SCREEN	—
• IP PARAMETER PROGRAMMING MENU	28
11) TECHNICAL SPECIFICATIONS OF THE EXTENSION CABLE FOR Pt100	30
12) FCD FUNCTION	31
13) WARRANTY CONDITIONS	—
14) TROUBLESHOOTING	32
15) EQUIPMENT DISPOSAL	—
16) USEFUL CONTACTS	—
17) UL SPECIFICATION AND RATINGS	33

SAFETY REQUIREMENTS



ATTENTION:

Carefully read the manual before starting using the control unit. Keep the instructions for future reference.



Do not open the device, touching any internal component can result in electric shock as voltages over 50 volts can be lethal. In order to reduce the risk of electric shock, do not disassemble the back of the device. Warranty shall be void if device is opened.

Before connecting the device to the power supply, ensure that all the connections are correct. Always disconnect the unit from the supply before making any modification on the wiring.



Any operation on the equipment must be operated by a qualified technician.

Failure to comply with these instructions can cause damages, fires or electric shock, and possible serious injuries!

POWER SUPPLY

The NT935 ETH control unit can be supplied from 85 to 260 Vac-Vdc, irrespectively of polarity in Vdc. Before use, ensure that the power cable is not damaged, knotted or pinched. Do not tamper with the power cable. Never disconnect the unit by pulling the cable, avoid touching the clamps. Do not carry out any connecting/disconnecting operation with wet hands. To disconnect the device, do not use objects such as levers. Immediately disconnect the device if you smell burning or see any smoke: contact technical service.

LIQUIDS

Do not expose the equipment to liquid spurts or drops, do not position it in places where humidity exceeds 90% and never touch it with wet or humid hands. If any liquid penetrates the control unit, disconnect immediately and contact technical service.

CLEANING

Disconnect the power cable before cleaning the control unit, using a dry cloth without any solvent or detergent, and compressed air.

OBJECTS

Never insert objects into the openings of the control unit. If this happens, disconnect the control unit and contact technical service.

USE RESERVED TO QUALIFIED PERSONNEL

The purchased good is an advanced electronic device that should not be used by non-qualified personnel. Any operation must be carried out by a qualified technician.

ACCESSORIES

The use of non-original accessories or spare parts may damage the unit and endanger users' safety. In event of fault, contact technical service.

LOCATION

Install the control unit indoor, in a place protected from water splashes and sun rays. Do not place near heat sources if exceeding the parameters stated in this manual. Position on a stable surface, far from any possible vibrations. Position the unit as far as possible from intense magnetic fields.

REPAIRS

Do not open the control unit. In case of fault, always contact qualified personnel. The opening of the control unit and/or the removal of the series identifying label automatically make the warranty void. The warranty seal is applied to all devices, any attempt to open the unit would cause the seal to break the consequent automatic cancellation of the warranty.

FUNCTION

To control the transformer correctly from a temperature point of view, enabling the VOTING function is allowed where the load distributed between the phases of the transformer is adequately balanced.

TECHNICAL INFORMATION

Mail: ufficiotecnico@tecsystem.it — tel: 02/4581861

ACCESSORIES

The following objects are present inside the box:

Control unit



Start guide and QR code



2 blocks for panel mounting

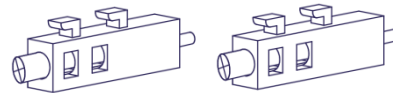

1 supply terminal 3 poles pitch 5
Code: 2PL0367 - Screws tightening torque 0.5Nm



1 relay terminal 12 poles pitch 5
Code: 2PL0361 - Screws tightening torque 0.5Nm



1 Pt100 sensors terminal 12 poles pitch 3.81
Code: 2PL0420 - Screws tightening torque 0.25Nm



ATTENTION: always install the device using the terminals included in the pack.
The use of terminals other than those included with the control unit might cause malfunctions.

TECHNICAL SPECIFICATIONS	NT935 ETH
POWER SUPPLY	
Supply rated values	85-260 Vac-Vdc 50/60HZ
Vdc with reversible polarities	•
INPUTS	
4 inputs for RTD sensors, Pt100 type with 3 wires (max section 1.5mm ²)	•
Connections on removable terminal strips	•
Input channels protected against electromagnetic interference	•
Cable compensation for thermistors	500m (1mm ²)
OUTPUTS	
2 alarm relays (ALARM AND TRIP) SPDT	•
1 sensor or operating failure (FAULT) relay SPST	•
Output relays with 10A-250Vac-res COS Φ =1 contacts.	•
2 ventilation management relays SPST FAN 1 AND FAN 2	•
Ethernet output 10Base T / 100Base-TX Modbus TCP slave.	•
DIMENSIONS	
100x100 mm– din43700-depth 131mm (terminal block included)	Hole 92 x 92 mm
TESTS AND PERFORMANCE	
Construction in compliance with CE regulations	•
Protection from electrical interference EN 61000-4-4	•
Dielectric strength 1500 Vac for a min. between output relays and sensors, relays and power supply, power supply and sensors	•
Accuracy $\pm 1\%$ v/s, ± 1 digit	•
Ambient operating temperature from -20°C to $+60^{\circ}\text{C}$	•
Humidity 90% non-condensing	•
Frontal film polycarbonate IP65	•

TECHNICAL SPECIFICATIONS	NT935 ETH
Housing NORYL 94 _V0	•
Absorption 7,5VA	•
Digital linearity of sensor signal	•
Self-diagnostic circuit	•
Protection treatment of the electronic part	Option
DISPLAY AND DATA MANAGEMENT	
2x13mm displays with 3 digits to display temperatures, messages and channels	•
3 LEDs to display the state of the alarms of the selected channel (ALARM-TRIP-FAULT)	•
4 leds selection of display mode (SCAN-AUTO-MAN-T-MAX)	•
2 LEDs to display the state of FAN1 and FAN2	•
Temperature control from 0°C to 240°C (*)	•
2 alarm thresholds for channels 1-2-3	•
2 alarm thresholds for channel 4	•
2 ON-OFF thresholds for FAN 1 and FAN 2	•
Sensor diagnostics (Fcc-Foc-Fcd)	•
Data memory diagnostics (Ech)	•
Access to programming through front keyboard	•
Automatic exit from relay programming, display and test after 1 minute's inactivity	•
Incorrect programming warning	•
Selection between channel automatic scanning, hottest channel or manual scanning	•
Storage of maximum temperatures reached by channels and alarm status	•
Front key to reset the alarms	•
Voting function	•
Intellifan function	•
Failsafe function	•

(*) On demand, available version from -40°C to 200°C with alarm temperature management range from 0°C to 200°C

FRONT PANEL

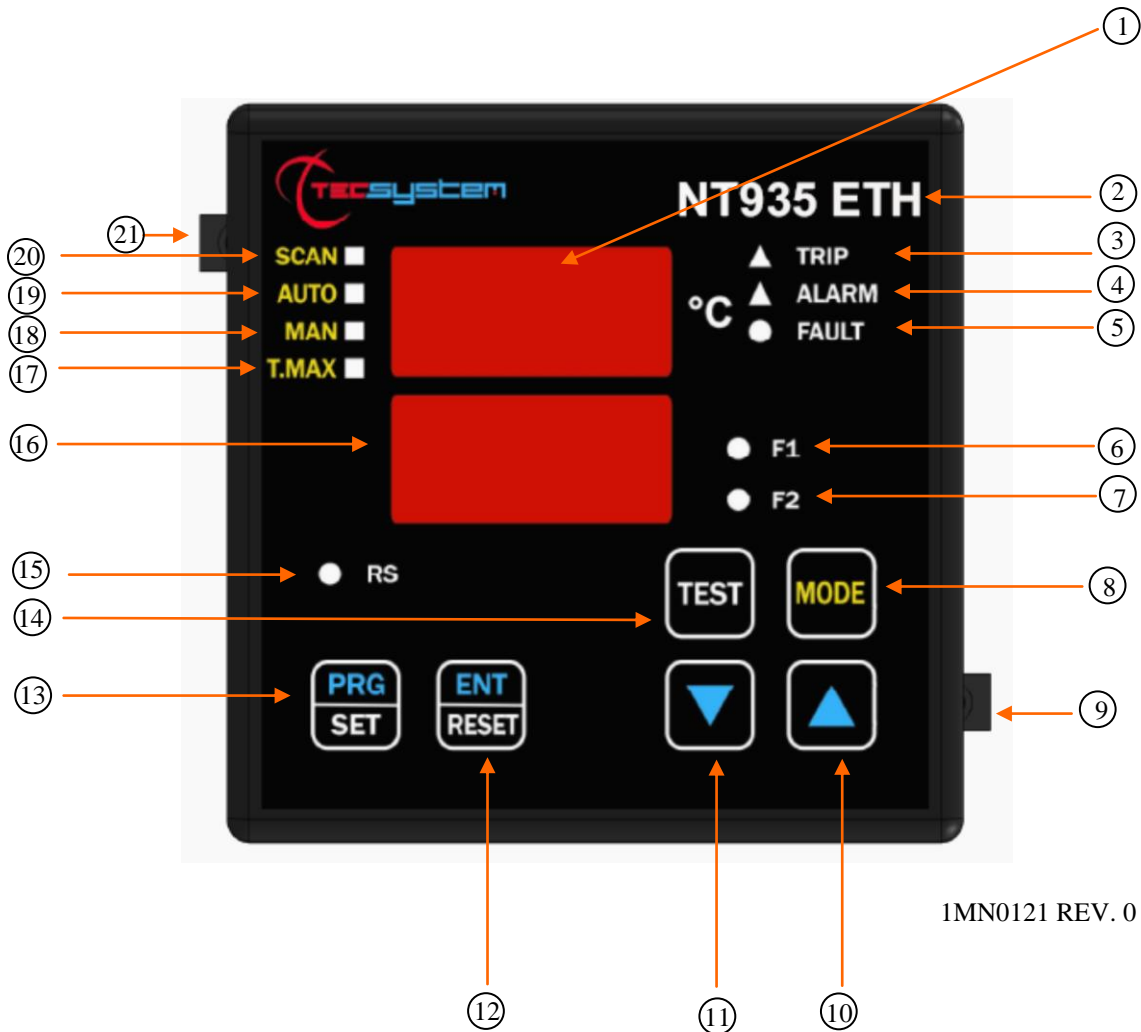

1MN0121 REV. 0

1)	3-digit temperature display	12)	Enter/Reset button
2)	Control unit series	13)	Programming / Setting key
3)	TRIP (red) LED	14)	LED/relay test key
4)	ALARM (yellow) LED	15)	RS (green) LED
5)	FAULT (red) LED	16)	3-digit channel display
6)	FAN 1 (yellow) LED	17)	T-max mode selection (red) LED
7)	FAN 2 (yellow) LED	18)	Man mode selection (yellow) LED
8)	Display mode selection key	19)	Auto mode selection (green) LED
9)	Fixing block	20)	Scan mode selection (yellow) LED
10)	UP key	21)	Fixing block
11)	DOWN key		

DISPLAY

The first display is dedicated to temperatures.

The second display to the monitored channel.

When the device is switched on or after a reset, the model of the control unit, the type of sensors, VER "00" (firmware version), the temperature range of the device and the unit identification are always shown on the display. Pressing the MODE key, the display modes can be set:

- **SCAN:** the monitoring unit displays all the activated (°C) and deactivated (NO) channels scanning every 2 seconds.
- **AUTO:** the monitoring unit displays the hottest channel automatically.
- **MAN:** manual reading of the channel temperature using the up/down keys ▲▼
- **T.MAX:** The display shows the maximum temperature of the channel selected with the cursor keys. In the event of fault, the Tmax value is replaced with the type of fault stored (fcc-foc-fcd). Turning ON of the leds Trip-Alarm-Fault LEDs alerts us to events that have occurred. The stored values are always successive to the moment of the last T-MAX reset, for resetting the values press the RESET key.

OPERATING PROGRAM CONTROL

To control the protection levels programmed, press the PRG key twice to access the **VIS** display mode. By repeatedly pressing the PRG key, you can scroll through all the previously loaded values in sequence. After 1 minute's keyboard inactivity, the programming display procedure is automatically abandoned.

To stop the display, press the ENT key.

NOTES ON SCAN AND MAN FUNCTIONS

During the SCAN and MAN modes, the operation of the NT935 can be displayed.

1) RUN cPU:

This message appears when the device is turned on.

2) Ech Err:

This message appears when a damage in the EEPROM memory is detected.

Pressing Reset will cancel the message and restore the original default parameters, listed in the programming paragraph on pages 13-14. Return the control unit to TECSYSTEM for repairs.

3) CAL Err:

This message appears when damage is found in the measurement circuit.

The temperature values displayed might be incorrect. Return the control unit to TECSYSTEM for repairs.

4) Pt Err:

This message appears when it is detected that one or more PT100 sensors are not working correctly, FOC, FCC and FCD indications in the temperature sensor diagnostics paragraph on page 16.

In case of **Err** the FAULT relay will be de-energised.

The above messages will be displayed following the 1-2-3-4 priority stated.

NOTE: regardless of the display mode, in case of a sensor fault (fcc, foc or fcd), the control unit will automatically switch to **SCAN (PRIVILEGED SCAN)** mode, immediately allowing you to see the fault on the relative channel **CH**. (**Mode** key is disabled).

LED TEST

We suggest carrying out the control unit LED test regularly.

For this operation, press the TEST key briefly; all the displays turn on for 2 seconds.

If one of the LEDS does not work, please return the control unit to TECSYSTEM for repair.

ALARM RELAY TEST

This function allows you to carry out a test of the relay operation without having to use further devices. To start the test procedure, keep the TEST button pressed for about 5 seconds: TST appears for 2 seconds, confirming you have entered the Relay Test mode.

The LED that is lit shows the relay to be tested; use the cursors ▲▼ to select the desired relay.

Press the SET and RESET keys to energise and de-energise the relay to be tested; the display will show ON-OFF.

After 1 minute's keyboard inactivity, the RELAY TEST procedure will be automatically abandoned.

To stop the RELAY TEST procedure, press the TEST key.

Alternatively, you can use the PT100 simulator model: SIM PT100.

ALARM RELAY SILENCING

If you want to silence the ALARM signal press the RESET key: the relay de-energises and the ALARM LED, which was fixed, will start flashing.

Silencing is automatically disabled when the temperature goes below the ALARM threshold.

MOUNTING

Drill a 92 x 92 mm hole in the panel sheet.

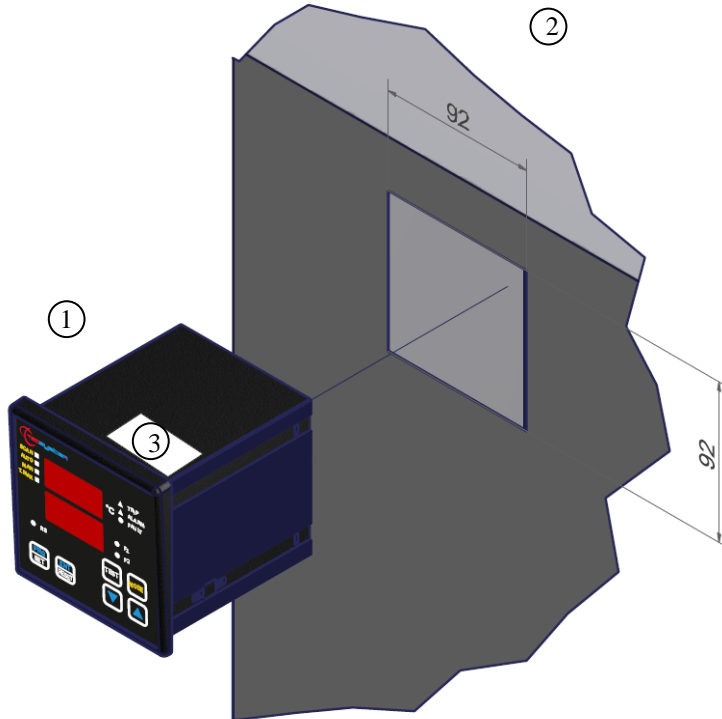

1MN0007 REV. 0

1)	Control unit	2)	Panel hole dimensions (+0.8mm tolerance)
3)	Identification label		

Fix the unit securely with the blocks supplied.

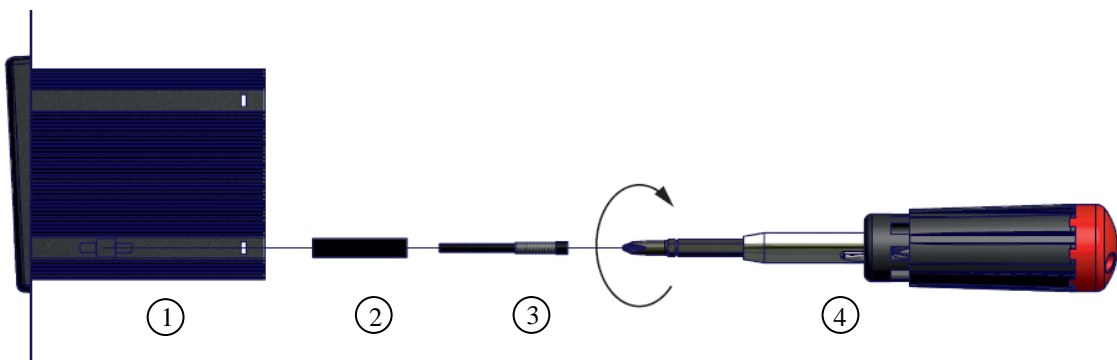

1MN0008 REV. 0

1)	Control unit	3)	Fixing screw
2)	Fixing block	4)	Cross-head screwdriver #1X100mm

ELECTRICAL CONNECTIONS

NT935 ETH

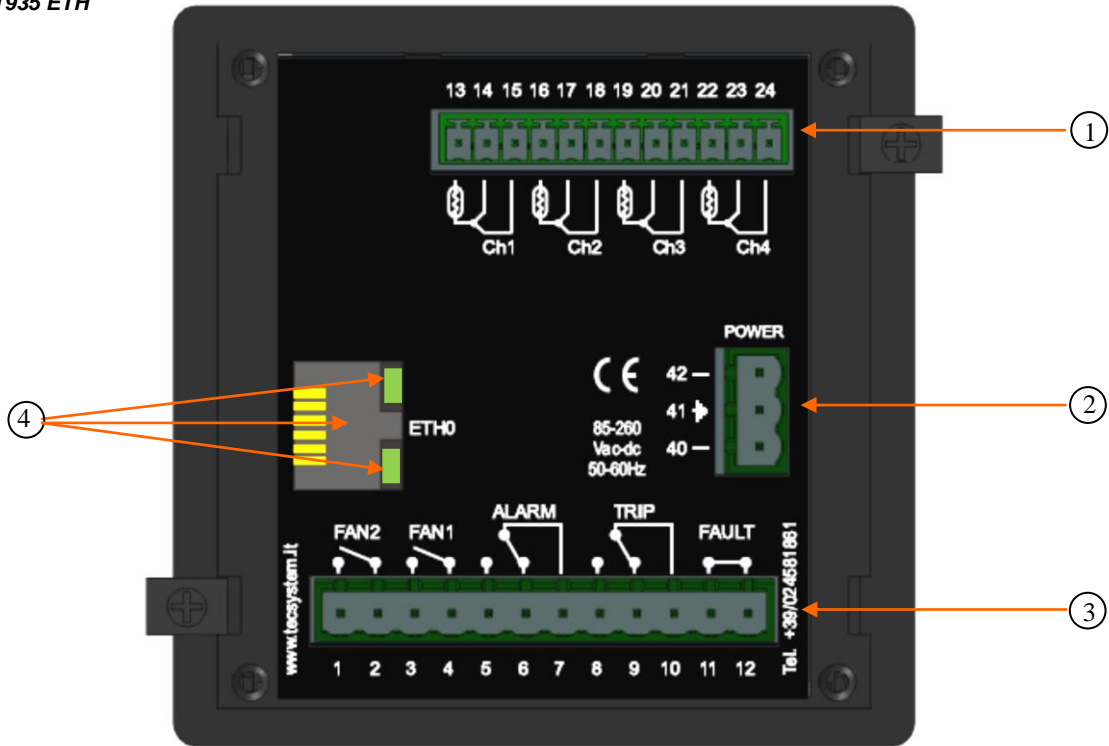

1)	Pt100 sensors (white-red-red)	3)	Relays (FAN2-FAN1-ALARM-TRIP-FAULT)
2)	Supply 85-260Vac-dc 50/60Hz.	4)	RJ45 Ethernet output, Link-Activity LED, see indication on page 30.

Note: relay contact image in non-alarm condition, with the exception of the FAULT relay that switches: contact 11-12 open (NO) contacts 11-12 closed (NC) fault condition identification. Read the Alarms and Ventilation paragraph on page 12 and see the opening of the fault contact.

RELAY CONNECTION EXAMPLE

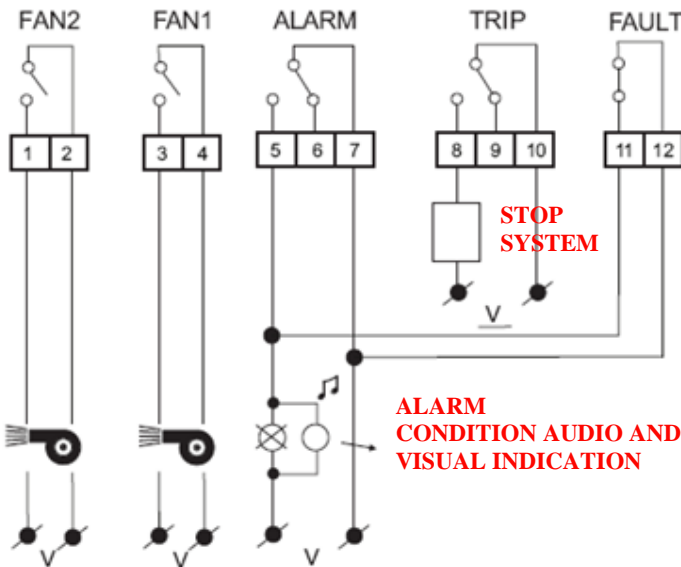

Output relay with 10A-250Vac-res COS Φ =1 contacts.

1MN0095 REV. 0

Pt100 CONNECTION EXAMPLE

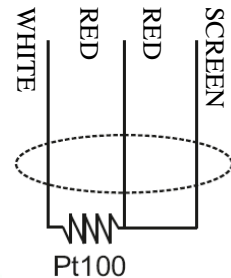

Note: before connecting the sensors to the control unit, read the Measurement signal transfer paragraph on page 15.

POWER SUPPLY

The NT935 control unit can be supplied by 85 to 260 Vac-Vdc, 50/60 Hz irrespectively of polarity in Vdc (terminals 40-42).

This is obtained thanks to the use of a tested power supply unit, newly designed and manufactured, that frees installers from worrying about the correct Vac and Vdc supply.

The ground must always be connected to terminal 41.

When the unit is supplied directly by the secondary of the transformer to protect, it can be burnt out by strong overvoltages.

This happens if the main switch is closed and the transformer has no load (blank test).

The above-mentioned problems are much more evident when the 220 Vac voltage is taken directly from the transformer secondary bars and there is a fixed capacitor battery to phase the transformer itself.

To protect the control unit from line overvoltages, we suggest using the PT-73- 220 electronic discharger, designed by TECSYSTEM S.r.l. for this specific purpose. As an alternative we suggest using 110 Vac or, even better, 110 Vdc supply voltages.

If an existing control unit must be replaced with a new one, to guarantee its correct and safe operation, the sensor/relay/supply connecting terminals must be replaced with the new terminals supplied.

ALARMS AND VENTILATION

Carry out the electrical connections on the removable terminal blocks only after disconnecting them from the unit. When the control unit is in one of the modes mentioned below, it does not monitor the temperature and the relays are all blocked. The fault contact switches and the fault LED flashes.

- Vis. programming display
- PRG Programming
- Relay test

The ALARM and TRIP relays switch only when the set temperature thresholds are exceeded.

The FAULT contact, programmed in failsafe mode (default YES), opens (11-12) when the equipment is supplied only if the unit detects no fault on switching on, and stays in this condition until one of the following events occurs:

- Data memory fault (Ech message).
- Pt100 sensor fault (FCC short-circuited sensor, FOC interrupted sensor or Fcd quick temperature increase)
- CAL damage to the measurement circuit.
- Insufficient supply voltage.
- During the power on reset after programming (PRG), displaying the data (VIS) and test relay.

The FAULT failsafe can be disabled selecting FAULT failsafe "NO" see step 34-35 programming page 14.

NOTE: do not connect the FAULT relay to the transformer tripping circuit to avoid unwanted system interruptions.

FAULT CONTACT (failsafe enabled)

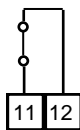

FAULT 11-12 NC: ALARM FAULT OR POWER OFF

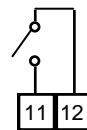

FAULT 11-12 NO: POWER ON OR NO FAULT

The FAN1 and FAN2 contacts can be used to control the cooling fans, or they can be inserted in the conditioning system of the transformer room, see paragraph Fan control on page 17.

NOTE: always disconnect the unit before performing any electrical connections.

FAULT AND RESET MESSAGE SEQUENCE



























Find below the sequence of fault messages and RESET function condition.

- | | | |
|-----------|----------------------------|--------------------------|
| 1) ECH | EEPROM fault | erasable message |
| 2) CAL | measurement circuit fault | erasable message |
| 3) FCD | quick temp. increase fault | resettable condition |
| 4) ERR PT | FCC or FOC sensor fault | non-resettable condition |

PROGRAMMING

NT935 ETH

STEP	PRESS	EFFECT	PRESS	NOTES
1		Keep the PRG key pressed until the display shows PRG SET		
2		Select PRG SET for entering in the programming mode or PRG 1 to restore the default programmed value.	 	PRG 1 default value
3		The ALARM threshold for (CH 1-2-3) is displayed Set the desired threshold, the Alarm LED flashes.	 	Default 90°C
4		The TRIP threshold for (CH 1-2-3) is displayed and the Trip LED flashes.		
5		Set the desired threshold	 	Default 119°C
6		FAN1 (CH 1-2-3) is displayed and the Fan1 LED flashes.		Default YES
7		Select YES / NO / INT	 	If you select INT, read the function notes on page 17
8		(CH4) is displayed CH4 enabling		
9		Set YES or NO	 	with YES CH4 is enabled with NO CH4 is disabled
10		The ALARM threshold for (CH4) is displayed, the Alarm LED flashes.		If CH4=NO go to step 16, Default NO
11		Set the desired threshold	 	Default 120°C
12		The TRIP threshold for (CH4) is displayed, the Trip LED flashes.		
13		Set the desired threshold	 	Default 140°C
14		FAN2 for (CH4) is displayed		Default Yes
15		Select YES or NO	 	
16		ON (CH 1-2-3) is displayed and the FAN1 LED flashes.		Default 70°C
17		Set the desired FAN1 ON threshold	 	If you select FAN1 NO, go to step 21 if you select INT the FAN1 and FAN2 LEDs flash.
18		OFF (CH 1-2-3) is displayed, the FAN1 LED flashes		Default 60°C
19		Set the desired FAN1 OFF threshold	 	

20		ON (CH4) is displayed, the FAN2 LED flashes		Default 45°C
21		Set the desired FAN2 ON threshold	 	If you select FAN2 NO, go to step 24
22		OFF (CH 4) is displayed, the FAN2 LED flashes		Default 35°C
23		Set the desired FAN2 OFF threshold	 	
24		HFN (NO) is displayed The FAN1-FAN2 LEDs flash		Fan cyclic test for 5 min. every "n" hours
25		Set the desired number of hours	 	Default NO = function disabled
26		FCD (NO) is displayed		Fault for quick temperature increase (°C/sec)
27		Set the desired value (FCD info on page 31)	 	Default NO (function excluded)
28		VOT (NO) is displayed (VOTING info on page 16)		
29		Set YES or NO	 	Default NO (function excluded)
30		The display shows FLS (ALARM) flashing LED ALARM (info FAIL SAFE on page 25)		
31		Set YES or NO	 	Default NO
32		The display shows FLS (TRIP) LED flashes TRIP		
33		Set YES or NO	 	Default NO
34		The display shows FLS (FAULT) LED flashes FAULT		
35		Set YES or NO	 	Default YES
36		END is displayed		End of programming
37		Press ENT to save the set data and exit programming		Err: incorrect programming of the LED values (note 6)
38		Return to step 1		

PROGRAMMING NOTES

- 1) The MODE key allows reversing the programming steps according to the sequence 28-26-8-1.
- 2) The TEST key allows exiting programming without saving the modified data.
- 3) After 1 minute's keyboard inactivity programming is abandoned without saving the data.
- 4) During programming the control unit does not control/protect the monitored machine.
- 5) At the end of programming the control unit is restarted and the FAULT relay is disabled until the unit is fully restarted.
- 6) If pressing ENT, "Err" appears, it means that one of the following mistakes has been made:

ERR ALL. = ALARM ≥ TRIP
ERR FAN = FAN-OFF ≥ FAN-ON. (FAN1 OR FAN2)
ERR INT = INT FAN-OFF ≥ FAN-ON (FAN1) DELTA <10°C

The device automatically switches to the programming step of the mistake.

NOTE: EVERY TIME THE CONTROL UNIT IS PROGRAMMED WITH DATA SAVING CONFIRMATION, THE VALUES STORED IN T-MAX ARE RESET TO THE TIME OF SAVING.



ATTENTION:

We recommend you check the unit's programming before starting the device.

The default parameters set by TECSYSTEM might not match your requirements.

Programming the device is the end user's responsibility, the settings of the alarm thresholds and the enabling of the functions described in this manual must be checked (by a specialized engineer) according to the application and features of the system the control unit is installed on.

TEMPERATURE SENSORS

Each Pt100 thermometric sensor has one white and two red connectors (CEI 75.8 regulations).

The CH2 channel must be always referred to the central column of the transformer.

The CH4 channel must be always referred either to the core of the transformer or to the Pt100 ambient sensor if you wish to thermo-regulate the transformer room using the NT935 ETH control unit.

MEASUREMENT SIGNAL TRANSFER

All the cables transferring the Pt100 measurement signals must comply with the following under all circumstances:

1. Every Pt100 must be connected with a three-wire cable having a minimum section of 0.35mm² and a maximum of 1 mm².
2. The extension cable must be screened with tinned copper braid with an 80% cover
3. Conductors must be twisted, maximum recommended step 60mm
4. The cable screening must be grounded only with a termination, preferably on the unit side.
5. The sensors' signal transfer cable must not be near electrical cables, either low or medium-high voltage.
6. The Pt100 cable and the signal transfer cable must be laid in a straight line, without any winding.
7. Any caps used to butt conductors must be crimped properly to avoid false contacts.

NOTE: to install the sensors and signal transferring cable correctly, read the SCS/ SENSOR installation rules manual.

What may happen when installation rules are not complied with.

1) The electrical field propagating from the power line of another circuit, couples capacitively with the conductors (in particular with unscreened cables). The effect of this coupling creates a signal that overlaps the signal transmitted by the nearby conductors, causing incorrect readings.

2) The variations in magnetic flux in the power lines may induce an electromotive force on the signal transferring cables (in particular non-twisted cables), that, being a closed circuit, generates a current. This interference current, multiplied by the circuit resistance, gives a voltage value that overlaps the signal to be transmitted, distorting the sensor measurement.

3) False contacts can alter the signal with the consequent variation in the temperature detected.

In specific cases, when the rules for connecting the Pt100 sensors are not complied with, the following anomalies can occur between the SCS box and the temperature control unit:

- a) incorrect temperature readings, alarms or anomalous tripping
- b) mechanical / electrical fault of the Pt100 sensors
- c) damage to the Pt100 inputs of the control unit.

TECSYSTEM S.r.l. has designed its own special cable to transfer the measurement signals, CEI-compliant, with all the protection requirements provided for: model **CT-ES**

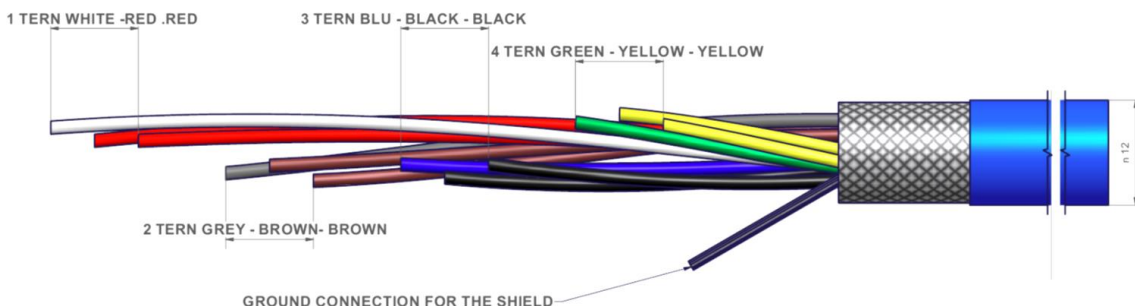

NOTE: the use of cables not complying with the above might cause reading anomalies. It is always important to take into account that any interference on the signal lines might cause anomalies on the Pt100 inputs (CH1-CH2-CH3-CH4...) or on the sensors themselves.

All "NT" series control units have linearity of the sensor signal, with a maximum error of 1% of full scale value.

TEMPERATURE SENSOR DIAGNOSTICS

In case of failure or exceeded full scale value of one of the thermometric sensors installed on the machine to protect, the **FAULT** relay opens immediately with the relative warning of faulty sensor on the corresponding channel (PT err).

Fcc indicates sensor short-circuited or minimum full scale value of the control unit exceeded -8°C (version $0^{\circ}\div 240^{\circ}\text{C}$) and -48°C (version $-40^{\circ}\text{C}\div 200^{\circ}\text{C}$)

Foc indicates sensor interrupted or maximum full scale value of the control unit exceeded 243°C (version $0^{\circ}\div 240^{\circ}\text{C}$) and 203°C (version $-40^{\circ}\text{C}\div 200^{\circ}\text{C}$)

To eliminate the message and reset the opening of the Fault contact, it is necessary to check the Pt100 connections and replace the faulty sensor (if any). If the minimum/maximum full scale value has been reached, check that the ambient conditions match the control unit reading.

Note: exceeding the minimum/maximum full scale value can also be caused by interference on the sensor lines; in this case we recommend that you check:

the correct installation of the sensors and above all of the extension cable (as stated in the paragraph MEASUREMENT SIGNAL TRANSFER)
the activation of: VOTING (see below) or FCD (see page 31) according to the conditions of the system.

CAL message display: it appears when damage is found in the measurement circuit. The temperature values displayed might be incorrect. Return the control unit to TECSYSTEM for repairs.

VOTING FUNCTION

The voting function derives from the redundancy concept that consists in duplicating the components of a system to increase their **reliability**.

How does VOTING work?

Using the redundancy principle, we use the sensors installed on the three phases U-V-W to monitor the transformer's operation, and at the same time ascertain the sensors are working correctly, discriminating against any false alarms (generated by installation errors).

By activating the **VOTING "YES"** function, the control unit compares the temperature values recorded on the monitored CH1-CH2-CH3 channels and enables the switching of the **TRIP** contact only if the **TRIP** threshold has been exceeded on at least two channels over the same period T.

By selecting **VOTING "NO"** the function will be disabled.

Note: by setting Voting "Yes" the switching of the **ALARM** contact will anyway indicate the alarm threshold on each individual channel has been exceeded.

To enable the Voting function, read the programming section on pages 13-14.



Attention: To control the transformer correctly from a temperature point of view, enabling the VOTING function is allowed where the load distributed between the phases of the transformer is adequately balanced. In addition, any conditions of FAULT: FCC-FCC-FCD on two or more channels, with active voting, can determine the TRIP contact inhibition.

PROGRAMMED DATA DIAGNOSTICS

In case of failure of the internal memory or corruption of programmed data, just after switching on, **Ech** appears with the relevant Fault contact.

In this case, for safety reasons, the default parameters are loaded automatically (see programming table on pages 13-14).

Eliminate **Ech** by pressing **RESET** and run programming to enter the desired values.

Finally switch the unit off and back on to check the memory works correctly, if it is damaged **Ech** will be displayed again (send the control unit to TECSYSTEM srl for repairs).

TEMPERATURE DIAGNOSTICS

When one of the temperature sensors senses a temperature 1°C higher than the alarm threshold, 5 seconds later the **ALARM** relay switches and the **ALARM LED** of the affected channel (CHn) lights up.

When the trip temperature limit is exceeded, 5 seconds later, the **TRIP** relay switches and the **TRIP LED** of the affected channel (CHn) lights up.

As soon as the recorded temperature returns to values equal to or lower than the limit set for the **ALARM** and **TRIP** relays switching, these relays de-energise and the corresponding LEDs switch off.

The **ALARM** and **TRIP** values are kept in the internal memory: they can be recalled by entering the Vis modes (programmed parameter display) and modified in PRG (programming) mode.

COOLING FAN CONTROL

The NT935 ETH control unit is fitted with two FAN controls (FAN1 and FAN2) and, if programmed correctly, can control the fans switching ON and OFF to cool the transformer.

The FAN1 and FAN2 contacts can manage cooling the transformer and the room where it is installed.

By connecting FAN1 to the tangential cooling system (the two bars on the transformer) and FAN2 to the extractor, you will improve the air flow in the cabin; moreover, the cabin temperature will no longer need to be managed by a thermostat outside the system.

The fans can be controlled in two different ways:

- Using the temperatures sensed by the sensors on the three columns
CHF 1.2.3
(ex. ON at 70°C - OFF at 60°C)
- Via an extra sensor (**CH4/YES**) dedicated to the ambient temperature inside the transformer room (FAN2).
CHF 4
(ex. ON at 45°C - OFF at 35°C)

The ON and OFF values are programmable according to the device range. FAN ON must always be greater by at least 1° C since FAN OFF (recommended ΔT FAN POWER ON-OFF + 10°C).

The FAN 1 / FAN 2 LED light up when the temperature exceeds 1°C the FAN ON threshold, the corresponding relay switches, and turns off when the temperature goes below 1°C the FAN OFF threshold, the corresponding relay switches.

FAN TEST

By programming (**HF_n**), it is possible to have the fans operating 5 minutes every "xxx" hours, regardless of the column or ambient temperature values (i.e.: with HF_n=001 the fans are activated for 5 minutes every hour). This function aims at verifying the fan operation and their control apparatus periodically.

By setting **NO** this function is inhibited.

To enable the HF_n function, read the programming section on pages 13-14.

INTELLIFAN FUNCTION

What it is used for:

The Intellifan function allows reducing the transformer's thermal shock by partially anticipating (one bar at the time) the activation of the tangential ventilation system.

The reduction in the transformer's thermal shock will extend the life of the transformer and of the ventilation system itself.

By enabling the **FAN1 "INT"** function, the control unit will alternate the activation (each 30 minutes) of the FAN1 and FAN2 contacts, anticipating the activation of the ventilation system at the intermediate value included between FAN1 ON and FAN1 OFF.

EX. FAN1 ON = 70°C and FAN1 OFF = 60°C **FAN INT. ACTIVATION = 65°C**

Before enabling the function, check that the connection of the two ventilation bars is distributed in such a way that the RH bar is connected to the FAN2 relay, pins 1-2, and the LH bar is connected to FAN1, pins 3-4.

By selecting **FAN1 "NO or YES"**, the function will be disabled.

Note: once the FAN1 threshold is exceeded, the control unit will activate both bars.

To enable the **INTELLIFAN** function, read the programming section on pages 13-14.

Note: for correctly working of the INTELLIFAN function we recommend you observe ΔT 10°C between FAN1 ON and FAN1 OFF. The connection to the VRT series devices, where Intellifan is enabled, must be made between the contacts FAN1 - COM-EN1 and FAN2 - COM-EN2.



IMPORTANT WARNING

Before carrying out the isolation test of the electrical panel the control unit is installed on, disconnect it together with the sensors from the power supply to prevent it from being seriously damaged.

ETHERNET MODBUS TCP OUTPUT

INTRODUCTION TO THE ETHERNET MODULE

The Ethernet connectivity of the new NT935 ETH allows you to implement the functions of the Tecsystem control units directly into your monitoring system, with maximum 8 Modbus TCP nodes.

The integrated module includes all the essential network features, among which a 10Base T / 100Base-TX Ethernet connection, TCP / IP full stack suitable to work as Modbus TCP slave.

The unit can be used for remote configuration, monitoring in real time or problem solving.

The Windows-based Telnet system allows configuring the NT935 ETH easily into a sub-network with specific IP addresses.

OPERATING NOTES

The communication of the temperature control monitoring unit is active only when the NT935 ETH is in temperature control mode (Scan, Auto, Man and T.Max).

When other functions such as programming, programming display and relay test are activated, the ModBus communication is temporarily deactivated.

DATA TRANSMISSION

The Ethernet module allows you to connect to the control unit through Modbus TCP slave so that you can: read the data on the Modbus table on page 20 and write those in the paragraph regarding the remote programming notes.

The ETH module is always in slave mode.

The NT935 ETH control unit is in communication with the network only when it is in temperature reading mode, while it is inactive when in the following modes: display, programming and relay test.

NOTES ON ETHERNET ELECTRICAL CONNECTIONS

As to the signal cable to use in order to guarantee correct operation, it is necessary to use a CAT 7 Ethernet cable with RJ45 connector with the following specifications:

- > 4 twisted pairs 23AWG
- > Tinned copper braid with an 80% cover.
- > Always position the Ethernet cable far from power cables.

FUNCTION CODE

The ModBus module supports the following function codes:

3₍₁₀₎: - holding register reading

16₍₁₀₎: - register multiple writing

If ModBus receives a message and a CRC error is detected, no answer is given.

CODE 3₍₁₀₎

Request:

Slave address, code 3₍₁₀₎, Starting address HI, Starting address LO, Number of Point HI, Number of Point LO, Crc LO, Crc HI.

Answer:

Slave address, code 3₍₁₀₎, Byte count, Data HI, Data LO....., Crc LO, Crc HI.

CODE 16₍₁₀₎

Request:

Slave address, code 16₍₁₀₎, Starting address HI, Starting address LO, Number of Point HI, Number of Point LO, Byte count, Data HI, Data LO....., Crc LO, Crc HI.

Answer:

Slave address, code 16₍₁₀₎, Starting address HI, Starting address LO, Number of Register HI, Number of register LO, Crc LO, Crc HI.

NOTES FOR REMOTE PROGRAMMING

The writeable registers are shown in the MODBUS MAPPING TABLE as W or RW (**write or read/write**) max number of registers 72, see table page. 20.

Channels 1÷3 are not disabled; in case of incorrect setting, they are always forced as enabled channels.

If the channel 4 is not enabled and/or the information is not provided for, the following answers are given:

1. **Measured temperatures** = 0000 (0°C)
2. **Temperature AL./TRIP** = Value written in E2PROM
3. **Channel state** = 0000
4. **Channel setting** = %00000000; %xxxxxxx0 (x=n.d.)

If writing information is sent towards a READ-only register, the data will be binned without affecting the message received.

Also in remote programming via ModBus you must take into consideration that the Alarm thresholds must be lower than the Trip thresholds and that the Fan-on thresholds must be higher than the Fan-off thresholds.

If you try to set these thresholds wrongly, the NT935 ETH monitoring unit won't proceed with programming and data storage; therefore in the following readings you will read the data relevant to the previous programming.

After sending a writing request, the monitoring unit will require approximately 1" to store the data in eeprom; during the storage phase, the ModBus module will not be able to process other requests.

If the programming request is successful, the control unit automatically resets and loads the newly set values.

The information "RELAY STATUS" indicates the state of excitation of the coils of the relays, so it will be subject to the commands of "FAIL SAFE".

At the end of the Write command, data compatibility is checked:

1. **in case of incompatibility, the answer is an "exception" and the data packet is refused in full. The code of the first wrong datum can be requested reading the "Datum error received" register. (NB: this code is lost during RESET, switching on or data writing in E2PROM);**
2. **if the data are correct, they are transferred into the non-volatile memory (E2PROM), historical data are cancelled (Tmax=0°C) and, then, a system RESET is forced.**
3. **If the WRITE command entails only writing "COMMANDS", it will be performed autonomously and without a RESET, that is without affecting the control unit data.**

ERROR CODES (exception codes)

In case of a wrong request, ModBus will answer with modified codes and codified errors according to the following:

- 1: - Unsupported function code
- 2: - Wrong data address
- 3: - Wrong data (for instance length)

The memory area containing the HFN datum must undergo no forcing.

In the case in which all the fans are turned off (F1, F2) the test of the relay will not take place.

UNACCEPTABLE DATA

Some programming is unacceptable since the NT935 ETH does not provide for it; these data are discarded with no EXCEPTION CODE.

- CH 1-2-3: → channels cannot be disabled
- CH 1-2-3: → FAN_2 cannot be enabled
- CH 4: → FAN_1 cannot be enabled
- CH 4: → FAN_INT cannot be enabled
- CH 4: → FAN_2 cannot be enabled if CH 4=no

GENERAL UNIT NOTE

The models of the unit can be equipped with different options ; to avoid disruption of production , their existence is defined by Fw indicated power , with messages dedicated on display LEDs .

This information can be accessed by reading the Modbus register 6 (option) with the following meaning :

LOW Byte

Bit_1 = Ethernet

HIGH Byte

Bit_0/1 = 00 - Range 0°C ÷ +240°C

Bit_0/1 = 10 - Range -40°C ÷ +200°C

In case of Ethernet option Modbus and 4.20mA mode shall not be active on the display. They will be readable from the log.

Note: in case the values programmed from ModBus are out of range, it will generate a "exception" error response to date.

ILLEGAL DATA

On the other hand, some combinations are programming errors because they are wrong settings; in this case the error code is ILLEGAL_DATA. This information is accessible to ModBus reading the register 7.

NO ERROR	No error 00
CH_1 Trip ≤ Alarm	Code error 01
CH_4 Trip ≤ Alarm	Code error 04
FAN_1 ON ≤ OFF 0 FAN INT ≤ 10	Code error 017
FAN_2 ON ≤ OFF	Code error 018
Value HFN > max see table: SYSTEM - Setting and Status	Code error 020
Value FCD > max see table: SYSTEM - Setting and Status	Code error 021
Value 4.20 > max see table: SYSTEM - Setting and Status	Code error 022
Value Voting > max see table: SYSTEM - Setting and Status	Code error 023

Note. If the value of Voting is higher than the max value expected for the model in question, it will be set equal to "0", that is NO_VOTING.

MODBUS MAPPING TABLE

HEADER (information and commands):

Address LO ⁽¹⁰⁾	Data HI	Data LO	R: read W:write RW: read/write
1	Modello – MSD (ASCII)	Modello - 3° Digit (ASCII)	R
2	Modello - 2° Digit (ASCII)	Modello – LSD (ASCII)	R
3	Space (20H)	Vers. Fw – MSD(ASCII)	R
4	Vers. Fw - 2° Digit (ASCII)	Vers. Fw – LSD(ASCII)	R
5	Channels qty (2*ASCII)		R
6	(Options see note)	Options (see note)	R
7	00	Wrong datum received	R-see tab.
8	00	Info various causes	R-see tab
9	00	Commands	W-see tab.

SYSTEM: Setting and Status

Address LO ₍₁₀₎	Data HI	Data LO	Note 1	Note 2	R: read W:write RW: read/write
10	00	HFN (Fan test)	0=No test	1÷200h	RW
11	00	FCD	temperature increment	0=No FCD 1÷30°/sec	RW
12	00	Voting	0=No Voting 1=YES		RW
13	00	CPU Setting	See Note		RW
14	00	CPU Error	See Note		R
15	00	Relays Status	See Note		R
16	00	420 mA channel	reference channel for 4.20 mA	0=hot 1÷4= ch1÷4 5=scan	RW Only for AD version
17	00	Address	Modbus address	1÷255	R
18	00	Bdr	Modbus baud rate	0=2400 1=4800 2=9600 3=19200 4=38400	R
19	00	Parity	Modbus parity bit	0=N-1 (1 stop) 1=Even 2=Odd 3= N-2 (2 stop)	R
20	00	FREE	See Note		R

TEMPERATURE FANS:

Address LO ₍₁₀₎	Data HI	Data LO	Note 1	Note 2	R: read W:write RW: read/write
21	2'compl. sign	Fan_1 ON	1°C ÷ 240°C 1°C ÷ 200°C (*)		RW
22	2'compl. sign	Fan_1 OFF	1° to÷ 240° 1°C ÷ 200°C (*)		RW
23	2'compl. sign	Fan_2 ON	1° to÷ 240° 1°C ÷ 200°C (*)		RW
24	2'compl. sign	Fan_2 OFF	1° to÷ 240° 1°C ÷ 200°C(*)		RW

(*) for version -40°C ÷ +200°C

TEMPERATURES channels 1÷4:

Address LO ⁽¹⁰⁾	Data HI	Data LO	Note 1	Note 2	R: read W:write RW: read/write
25	2'compl. sign	2'compl. Ch1 temper.	-10°C ÷ 240°C -48°C÷200°C (*)		R
26	2'compl. sign	2'compl. Ch1 max temperat.	0°C ÷ 240°C 0°C÷200°C (*)		R
27	2'compl. sign	2'compl. Ch1 temper. alarm set point	1°C ÷ 240°C 1°C÷200°C (*)	(AL)	RW
28	2'compl. sign	2'compl. Ch1 temper. trip set point	1°C ÷ 240°C 1°C÷200°C (*)	(TRP)	RW
29	2'compl. sign	2'compl. Ch2 temper.	-10°C ÷ 240°C -48°C÷200°C (*)		R
30	2'compl. sign	2'compl. Ch2 max temperat.	0°C ÷ 240°C 0°C÷200°C (*)		R
31	2'compl. sign	2'compl. Ch2 temper. alarm set point	1°C ÷ 240°C 1°C÷200°C (*)	As (AL)	R
32	2'compl. sign	2'compl. Ch2 temper. trip set point	1°C ÷ 240°C 1°C÷200°C (*)	As (TRP)	R
33	2'compl. sign	2'compl. Ch3 temper.	-10°C ÷ 240°C -48°C÷200°C (*)		R
34	2'compl. sign	2'compl. Ch3 max temperat.	0°C ÷ 240°C 0°C÷200°C (*)		R
35	2'compl. sign	2'compl. Ch3 temper. alarm set point	1°C ÷ 240°C 1°C÷200°C (*)	As (AL)	R
36	2'compl. sign	2'compl. Ch3 temper. trip set point	1°C ÷ 240°C 1°C÷200°C (*)	As (TRP)	R
37	2'compl. sign	2'compl. Ch4 temper.	-10°C ÷ 240°C -48°C÷200°C (*)		R
38	2'compl. sign	2'compl. Ch4 max temperat.	0°C ÷ 240°C 0°C÷200°C (*)		R
39	2'compl. sign	2'compl. Ch4 temper. alarm set point	1°C ÷ 240°C 1°C÷200°C (*)	(AL)	RW
40	2'compl. sign	2'compl. Ch4 temper. trip set point	1°C ÷ 240°C 1°C÷200°C (*)	(TRP)	RW
41	00	00			R
42	00	00			R
43	00	00			R
44	00	00			R
45	00	00			R
46	00	00			R
47	00	00			R

(*) for version -40°C ÷ +200°C

48	00	00			R
49	00	00			R
50	00	00			R
51	00	00			R
52	00	00			R
53	00	00			R
54	00	00			R
55	00	00			R
56	00	00			R

CHANNELs 1-4: Setting

Address LO (10)	Data HI	Data LO	Note 1	Note 2	R: read W:write RW: read/write
57	00	Ch1 Setting	See Note CHx		RW
58	00	Ch2 Setting	See Note CHx		RW
59	00	Ch3 Setting	See Note CHx		RW
60	00	Ch4 Setting	See Note CHx		RW
61	00	00	--		R
62	00	00	--		R
63	00	00	--		R
64	00	00	--		R

CHANNELs 1÷4: Status

Address LO ⁽¹⁰⁾	Data HI	Data LO	Note 1	Note 2	R: read W:write RW: read/write
65	Ch1 story	Ch1 status	See Note CHx		R
66	Ch2 story	Ch2 status	See Note CHx		R
67	Ch3 story	Ch3 status	See Note CHx		R
68	Ch4 story	Ch4 status	See Note CHx		R
69	00	00	--		R
70	00	00	--		R
71	00	00	--		R
72	00	00	--		R

REGISTER NOTE

INFO various causes (READ)

BIT 7	BIT 6	BIT 5	BIT 4	BIT 3	BIT 2	BIT 1	BIT 0
--	--	--	-	-	-	-	(*) RESET (R) has taken place

COMMANDS (WRITE)

BIT 7	BIT 6	BIT 5	BIT 4	BIT 3	BIT 2	BIT 1	BIT 0
--	--	--	-	-	(*) Reset CPU_Error	(*) Reset historical data	(*) Zero. BIT: RESET has taken place

CHn SETTING

BIT 7	BIT 6	BIT 5	BIT 4	BIT 3	BIT 2	BIT 1	BIT 0
--	--	--	--	FAN_INT	FAN2	FAN1	CAN_enabled

CHn STATUS

BIT 7	BIT 6	BIT 5	BIT 4	BIT 3	BIT 2	BIT 1	BIT 0
--	TRIP	ALARM	FAN_2	FAN_1	FCD	FOC	FCC

CHn STORY

BIT 7	BIT 6	BIT 5	BIT 4	BIT 3	BIT 2	BIT 1	BIT 0
--	TRIP	ALARM	--	--	--	FOC	FCC

RELAY STATUS (coil energizing status)

BIT 7	BIT 6	BIT 5	BIT 4	BIT 3	BIT 2	BIT 1	BIT 0
--	--	--	FAULT Relay 1=ON	TRIP Relay 1=ON	ALARM Relay 1=ON	FAN_2 Relay 1=ON	FAN_1 Relay 1=ON

CPU ERROR

BIT 7	BIT 6	BIT 5	BIT 4	BIT 3	BIT 2	BIT 1	BIT 0
--	--	--	--	PT ERROR	CAL	FCD Fault	ECH

CPU SETTING

BIT 7	BIT 6	BIT 5	BIT 4	BIT 3	BIT 2	BIT 1	BIT 0
--	--	--	Failsafe fault	Failsafe trip	Failsafe alarm	--	--

FAIL SAFE FUNCTION

The NT935 ETH has n.o selection (contact open) / n.c (normally closed contact) for ALARM, TRIP and FAULT relays, programming steps 30 to 35 page 14. The selection of the setting YES/NO introduces functions Fail Safe and No Fail Safe.

ALARM AND TRIP

Setting NO (NO Fail safe) normally open contacts are in positions 5-7 Alarm and 8-10 Trip, they switch only when limits are reached preset temperature.

Setting YES (Fail Safe) normally closed contacts are in positions 5-7 Alarm and 8-10 Trip, they switch only when limits are reached preset temperature or device's power supply lack.

FAULT

Setting YES (Fail safe) the contact 11-12 is positioned as normally open, switches (closed) when a fault condition is identified; see section on page 12 alarms and ventilation.

Setting NO (NO Fail safe) the contact 11-12 is positioned as normally closed, switches (open) when a fault condition is identified; see section on page 12 alarms and ventilation.

Disabling the failsafe function on the fault contact, the unit will no longer be able to report the fault for lack of power. In this case it is suggested that the enabling of the fail safe on the ALARM contact for the above indication.

NOTE: When the unit is located in one of the methods described below does not monitor heat, also the relay will all be banned, the FAULT led start blinking.

- Vis. display programming.
- PRG programming.
- Test of the relays.

The FAIL SAFE is temporarily disabled The FAULT relay switches.

ETHERNET MODULE PARAMETER PROGRAMMING

X Windows Vista, 7, 8.

ETH0 CONNECTIONS

Using an Ethernet cable, connect the RJ45 ETH0 of the NT935 ETH control unit to the ethernet card of a PC.

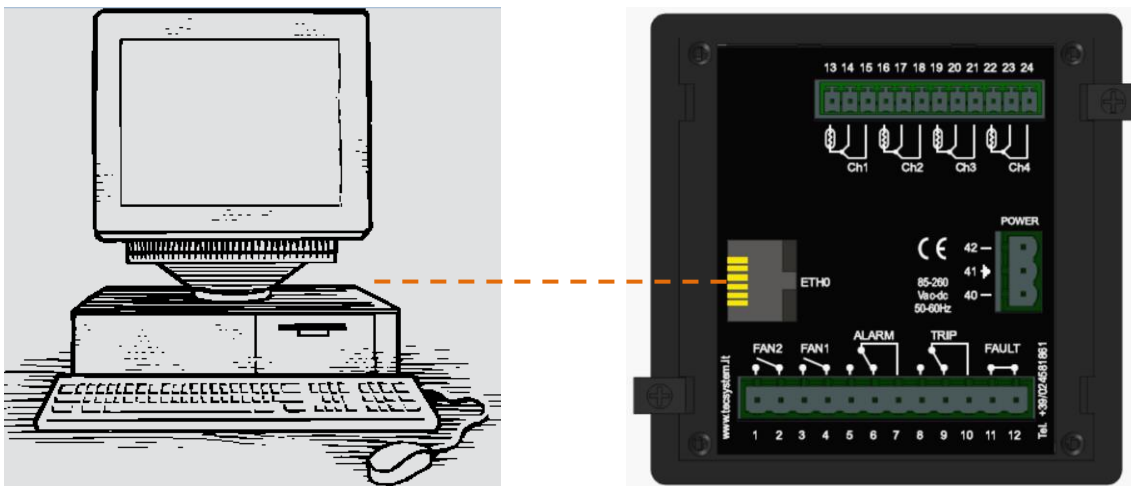

TELNET ENABLING

Use the Telnet program to set the Ethernet IP parameters.

1) START menu (Windows)

If already enabled, the program appears

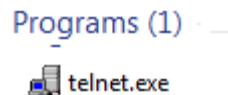

2) Start the search with the Telnet program
Entering telnet in SEARCH.

Press ENTER to launch the program.
(Go to step 12 on page 27)

If the Telnet program is not enabled:

3) START menu (Windows):

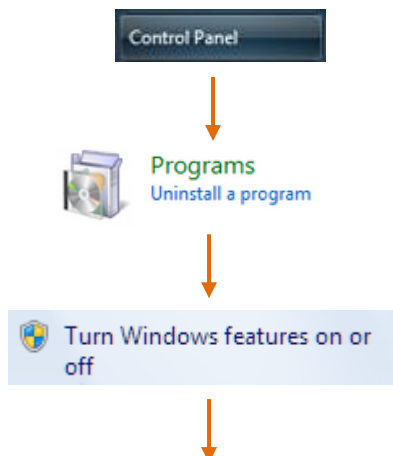

4) Select Control panel

5) Select Programs, followed by Features or Programs and Features

6) Select Turn Windows features on or off

7) Enable Telnet Client and click "OK"

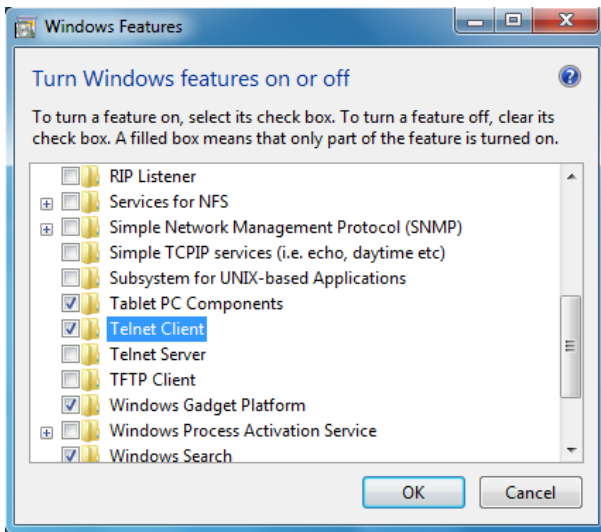

The screen below will open.
Wait for the Telnet function to activate.

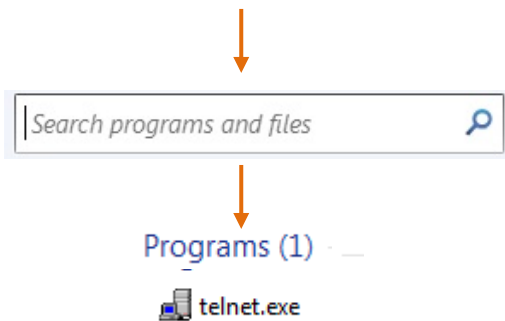
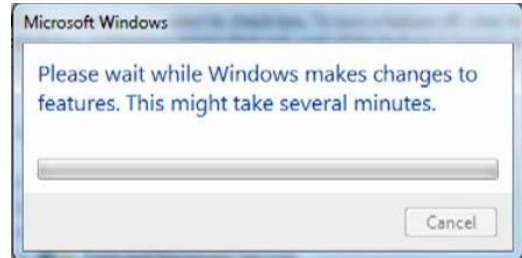

8) Close the open screens and restart the PC if required

9) START menu (Windows)

10) Search for the Telnet program

11) Press ENTER to launch the program

12) TELNET SCREEN

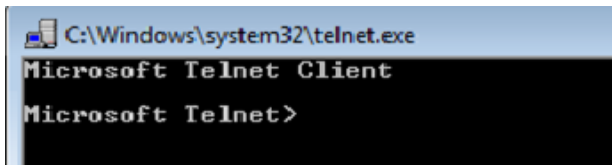

13) Enter: OPEN

14) Press ENTER

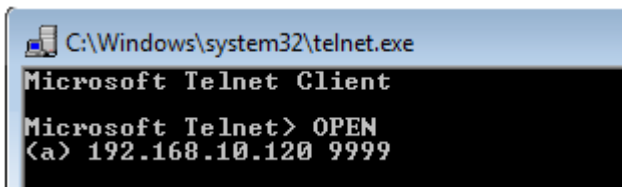

15) Enter: 192.168.10.120 9999

16) Press ENTER

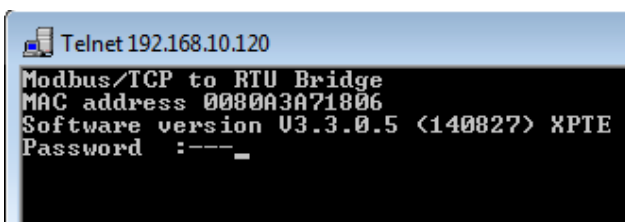

17) Enter the Password: TECS

18) Press ENTER

Note: In this screen we have the **MAC address** and the **software** version of the ETH port available.

19) IP PARAMETER PROGRAMMING MENU

```
Telnet 192.168.10.120
Modbus/TCP to RTU Bridge
MAC address 0080A3A71806
Software version U3.3.0.5 <140827> XPTC
Password :----
Press Enter for Setup Mode

Model: Device Server Plus+! <Firmware Code:YM>

Modbus/TCP to RTU Bridge Setup
1) Network/IP Settings:
   IP Address ..... 192.168.10.120
   Default Gateway ..... 192.168.10.1
   Netmask ..... 255.255.255.0
   Telnet config password set
2) Serial & Mode Settings:
   Protocol ..... Modbus/RTU,Slave(s) attached
   Serial Interface ..... 19200,8,E,1,RS485
3) Modem/Configurable Pin Settings:
   CP1 ..... RS485 Output Enable
   CP2 ..... Not Used
   CP3 ..... Not Used
4) Advanced Modbus Protocol settings:
   Slave Addr/Unit Id Source .. Modbus/TCP header
   Modbus Serial Broadcasts ... Disabled <Id=0 auto-mapped to 1>
   MB/TCP Exception Codes .... Yes <return 00AH and 00BH>
   Char. Message Timeout ..... 00050msec, 05000msec
7) Security Settings:
   SNMP ..... Enabled
   SNMP Community Name ..... public
   Telnet Setup ..... Enabled
   TFTP Download ..... Enabled
   Port 77FEh ..... Enabled
   Web Server ..... Enabled
   Enhanced Password ..... Disabled
   Port 77F0h ..... Enabled

D)default settings, S)ave, Q)uit without save
Select Command or parameter set <1..7> to change: _
```

IP PARAMETER PROGRAMMING MENU (TELNET)

The TELNET menu allows you to modify the configuration parameters of the Ethernet port.

The information available to you is:

Parameters that can be modified by the operator

- 1) Parameter modification (IP Address - Gateway- Netmask -Telnet password).

Parameters that cannot be modified by the operator

- 2) Communication parameters between the ETH0 port and the control unit.
- 3) Communication configuration between the ETH0 port and the control unit.
- 4) Communication advanced settings between the ETH0 port and the control unit.
- 7) Security settings between the ETH0 port and the control unit.



IMPORTANT WARNING

For the device to work correctly, we advise you not to access or modify menus 2-3-4-7. The modification of the values in the stated menus might cause communication anomalies with the loss of the Ethernet IP communication.

MENU MODIFICATION PROCEDURE 1) IP parameters:

enter the command: 1

```
IP Address: IP Address <192> 192.<168> 168.<010> .<120> 120_
```

1) Enter the desired new IP address, if you wish to keep the set address press ENTER 4 times.

- At the end of the operation, the system will ask if you wish to modify the Gateway IP:

```
IP Address <192> 192.<168> 168.<010> .<120> 120  
Set Gateway IP Address <N> ?
```

Enter: **Y** to modify the Gateway IP.

N not to modify the Gateway IP and go to the following step.

2) Enter the desired new Gateway IP address, press ENTER; if you wish to keep the set address press ENTER 4 times.

```
IP Address <192> 192.<168> 168.<010> .<120> 120  
Set Gateway IP Address <N> ? Y  
Gateway IP Address : <192> 192.<168> 168.<010> 10.<001> 001_
```

- At the end of the operation, the system will ask if you wish to modify Netmask:

```
IP Address <192> 192.<168> 168.<010> .<120> 120  
Set Gateway IP Address <N> ? Y  
Gateway IP Address : <192> 192.<168> 168.<010> 10.<001> 001  
Set Netmask <N for default> <N> ?
```

Enter: **Y** to modify Netmask.

N not to modify Netmask and go to the following step.

3) Enter the new Netmask, press ENTER; if you wish to keep the set address press ENTER 4 times.

```
IP Address <192> 192.<168> 168.<010> .<120> 120  
Set Gateway IP Address <N> ? Y  
Gateway IP Address : <192> 192.<168> 168.<010> 10.<001> 001  
Set Netmask <N for default> <N> ? Y  
<255> .<255> .<255> .<000> _
```

- At the end of the operation, the system will ask if you wish to modify the Telnet Password:

```
IP Address <192> 192.<168> 168.<010> .<120> 120  
Set Gateway IP Address <N> ? Y  
Gateway IP Address : <192> 192.<168> 168.<010> 10.<001> 001  
Set Netmask <N for default> <N> ? Y  
<255> .<255> .<255> .<000>  
Change telnet config password <N> ? _
```

Enter: **Y** to modify the Telnet Password.

N not to modify the Telnet Password and go to the following step.

```

IP Address (192) 192.(168) 168.(010) .(120) 120
Set Gateway IP Address (N) ? Y
Gateway IP Address : (192) 192.(168) 168.(010) 10.(001) 001
Set Netmask (N for default) (N) ? Y
(255) .(255) .(255) .(000)
Change telnet config password (N) ? Y
Enter new Password:

```

4) Enter the new Telnet Password (4 digits max), press ENTER; if you wish to keep the set Password, press ENTER.

```

D)efault settings, S)ave, Q)uit without save
Select Command or parameter set (1..7) to change: _

```

Enter: S to save the modified data.
Q to exit Telnet without saving the data.

The following screen will be displayed:

```

→ D)efault settings, S)ave, Q)uit without save
Select Command or parameter set (1..7) to change:
Parameters saved, Restarting ...

```

To check the programmed parameters or repeat programming, follow the TELNET SCREEN from step 12 to step 19, page 27.

Indications of LEDs 1-2 of the Ethernet port:

LED 1: Link

- > Off = No link
- > Amber = 10 Mbps
- > Green = 100 Mbps

LED 2: Activity

- > Off = No Activity
- > Amber = Half Duplex
- > Green = Full Duplex



TECHNICAL SPECIFICATIONS OF THE EXTENSION CABLE FOR Pt100

1. Cable 20 x AWG 20/19 Cu/Sn
2. Section 0.55 mm²
3. Flame retardant insulation PVC105
4. CEI 20.35 IEC 332.1 regulations
5. Maximum operating temperature: 90°C
6. Conformation: 4 sets of three twisted and coloured conductors
7. Shield in Cu/Sn
8. Flame retardant PVC sheath
9. External diameter 12mm
10. Standard conformation in 100m coils

FCD FUNCTION

The NT series equipment boasts an innovative control function combined with the dynamic status of the Pt100 sensor.

Activating FCD, the control unit analyses the increase in temperature ΔT (*) recorded in a second (**°C/sec**).

Enabling the function, the user can select the value (ΔT) from a minimum of 1°C/sec to a maximum of 30°C/ sec. If the value sensed is higher than the value set by the user, the control unit inhibits the possible activation of the ALARM and TRIP alarms and switches the FAULT relay (11-12), displaying the message "**Fcd fault**".

Example: if we set the function to 5°C, FAULT will switch for FCD only if the control unit senses an increase in ΔT of over 5°C in a second on the monitored system.

Setting "no" disables the FCD function.

When a channel is in FAULT for FCD, the relative Alarm and Trip warnings are inhibited on the single channel; therefore only the over-quick temperature increase is highlighted.

Press Reset to delete the FCD warnings on all channels and reset the FAULT relay.

Possible FCD applications

Identification of a possible induced interference on the Pt100 sensor line

If the installation instructions are not complied with (see page 15), any interference on the Pt100 sensor line can cause false readings or anomalous alarms.

Setting the FCD function in a temperature range of between 1°C and 10°C (5°C recommended), the effects caused by false readings can be suppressed and the alarm relay activation can be prevented, as shown above.

Corrective actions: check the installation of the sensor extension cable is in line with the instructions given in the paragraph on the measurement signal transfer on page 15.

Identification of a sensor fault or faulty connection

In case of a faulty connection or sensor fault, a quick positive or negative variation in temperature might occur, leading to the system tripping or the alarms of the monitored system to be triggered.

In this specific case we recommend the FCD function to be set in a temperature range of between 10°C and 20°C.

Corrective actions: check the terminals the sensor is connected to are tightened and replace the faulty sensor, if required.

Identification of the electrical motor rotor block

In case of temperature control of the electrical motors, the quick temperature increase might be due to a blocked rotor.

In this specific case we recommend the FCD function to be set in a temperature range of between 20°C and 30°C. This setting is recommended in order to prevent the FCD function from activating during motor start-up, or where the ΔT /sec. increase varies quickly.

(*) The ΔT value shows the temperature range for each second.

NOTE: you should not enable the FCD function with active VOTING.

WARRANTY CONDITIONS

The Product purchased is covered by the manufacturer's or seller's warranty at the terms and conditions set forth in the "Tecsystem s.r.l.'s General Conditions of Sale", available at www.tecsystem.it and / or purchase agreement.

The warranty is considered valid only when the product is damaged by causes attributable to TECSYSTEM srl, such as manufacturing or components defects.

The warranty is invalid if the Product proves to have been tampered with / modified or incorrectly connected and causing voltages outside the set limits and does not comply with the technical data for use and assembly, as described in this instruction manual.

The warranty is always ex Corsico as stated in the "General Conditions of Sale".

TROUBLESHOOTING	CAUSES AND SOLUTIONS
The control unit does not switch on and the supply to terminals 40-42 is correct.	Check that: the connector is correctly inserted into its housing, the wires are tightened, there is no evidence of burning on the connectors. Disconnect the power supply, carry out the above and reconnect.
CH4 is in FAULT because of FOC (only the 3 Pt100 sensors are connected)	Programming error of the CH4 / YES control unit. <i>Check and repeat programming as per page 13-14, select CH4 / NO.</i>
One of the three/four channels is in FAULT due to FOC/FCC	Check the connections of the Pt100 sensors, check the instructions given in the paragraphs: <i>measurement signal transfer and temperature sensor diagnostics on page 14-15.</i>
When turning on, the display shows "ECH"	Strong interference damaged the stored data. See the paragraph Programmed data diagnostics on page 16.
All the PT100 sensors are in FCC.	Incorrect sensor connection, the terminal block has been inserted upside down. <i>Check the connections and the terminal board.</i>
The temperature shown by one or more channels is wrong.	Contact the <i>TECSYSTEM Technical Department.</i>
Sudden trip of the main switch. The temperature is on standard levels. Just one channel has caused the trip.	Check the temperatures recorded in T-MAX, check the instructions given in the paragraphs: <i>measurement signal transfer and temperature sensor diagnostics on page 16. Activate the FCD function.</i>
FCD warning	See the FCD function on page 31.
Contact <i>TECSYSTEM Technical Department</i> if the problem persists.	

EQUIPMENT DISPOSAL

European directive 2012/19/EU (WEEE) has been approved to reduce electrical and electronic waste and promote the recycling and reuse of the materials and components of said equipment, cutting down on the disposal of the residues and harmful components of electrical and electronic materials.



All the electrical and electronic equipment supplied after 13 August 2005 is marked with this symbol, pursuant to European directive 2012/19/EU on electrical and electronic waste (WEEE). Any electrical or electronic equipment marked with this symbol must be disposed of separately from normal domestic waste.

Returning used electrical devices: contact **TECSYSTEM** or your **TECSYSTEM** agent for information on the correct disposal of the devices.

TECSYSTEM is aware of the impact its products have on the environment and asks its customers active support in the correct and environmentally-friendly disposal of its devices.

USEFUL CONTACTS

TECHNICAL INFORMATION : ufficiotecnico@tecsystem.it

SALES INFORMATION : info@tecsystem.it



UL SPECIFICATION AND RATINGS

CABLE SPECIFICATION	Dimension for main circuit 18AWG, working temperature over 105°C
MASS OF THE EQUIPMENT	0,45 Kg
INPUT SUPPLY	100 – 240 Vac / Vdc ($\pm 10\%$), 50/60 Hz, 7,5VA max
PROTECTION	External switch or circuit breaker
OUTPUTS RELAYS	5 relay output: 10A 250Vac-res COS=1
PORT	Ethernet
Suitable for use on a flat surface of a type 1 enclosure if Back panel is provided with two short fixing screws tightening torque : 0.57Nm	